



**BALAGNE
MENUISERIE
CONCEPT**

ZA Cantone Voie N°3
20260 - CALVI

Tél : 04 95 31 82 89

Email : contact@bmc.corsica



Présentation d'entreprise p 4 - 5

Liste des Rals p 6

Principe du bioclimatique p 7

Pergolas p 8 - 25

Marbella - pergola à lames orientables manuelles

Panama - pergola à lames orientables motorisées

Castille - pergola à toiture fixe

Carports p 28 - 38

C150

C210

Brise soleil p 40 - 41







Avec Oriasun, profitez pleinement de vos extérieurs sous votre pergola, protégez votre véhicule grâce à nos carports ou bien apportez de l'ombre avec notre brise-soleil.

Bénéficiez d'une fabrication Française et du savoir-faire d'un spécialiste de l'aluminium.

Notre engagement qualité sera assuré de la conception à la livraison pour répondre aux plus hautes exigences.

Standard structure :



Blanc
9010
mat



Gris
7016
sablé

Standard lame :



Blanc
9010
mat

Sur mesure :



Vert
6005
sablé



Vert
6009
sablé

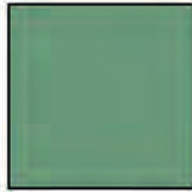

Vert
6021
sablé

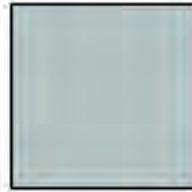

Gris
7035
sablé



Gris
7039
sablé



Gris
9007
sablé



Brun
8014
sablé



Brun
8019
sablé

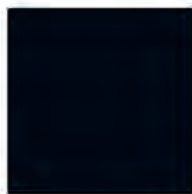

Noir
9005
sablé



Blanc
9016
sablé



Ivoire
1015
sablé



Rouge
3004
sablé



Bleu
5003
sablé

*Profitez de vos extérieurs tout le temps
par tous les temps !*

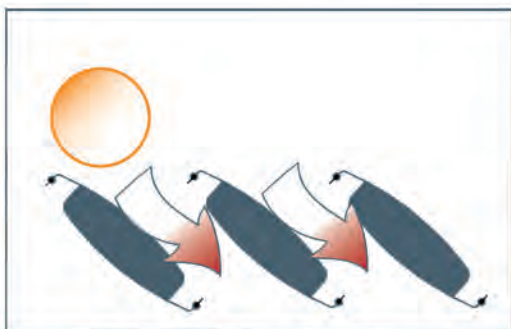

**Par temps frais,
laissez entrer la chaleur**

Gérez l'ensoleillement

Gérez librement l'orientation des lames, pour profiter pleinement du soleil ou pour créer une zone d'ombrage

Profitez de votre terrasse tout au long de l'année, grâce à nos pergolas.

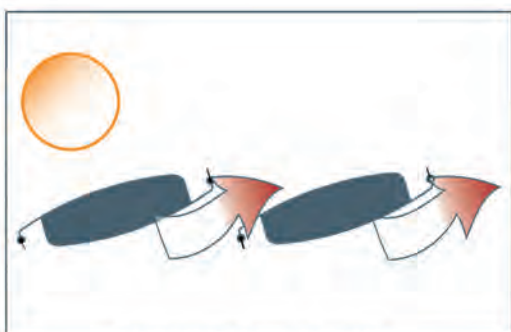

**Evacuez la chaleur,
pour éviter un effet de serre**

Ventilation Naturelle

Evitez l'effet de serre, en créant un mouvement d'air naturel.

L'air chaud s'évacue par l'ouverture des lames et permet une ventilation efficace

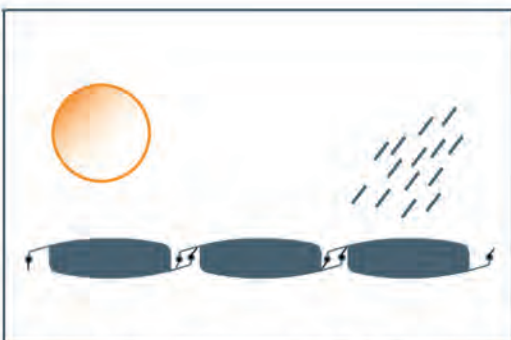

**Protection contre la pluie
et les rayons du soleil**

Protection contre la pluie et les rayons du soleil.

Lorsque les lames sont fermées, **nos pergolas sont étanches de lames à lames** et vous protègent efficacement contre les intempéries.

L'évacuation de l'eau se fait par les gouttières puis par les poteaux.

Attention, nos pergolas ne garantissent pas le hors d'eau, hors d'air telle une véranda





Pergola Marbella

Le Bioclimatique simplement



Protection contre les rayons du soleil et la pluie



Par temps frais, Laissez entrer la chaleur



Evacuez la chaleur, pour éviter un effet de serre

Manoeuvre des lames

Par manivelle Magnétique

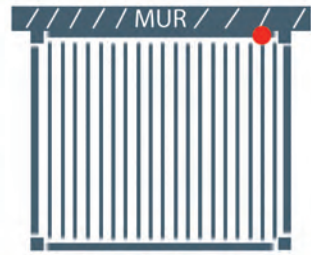

Vue de dessus

Dimensions

Standard : - 4,13x3,50x2,5 mètres
- 5,18x3,50x2,5 mètres
(Murale ou Autoportante)

Sur mesure max : 10,36 x 3,50m (2 modules)
hauteur max : 3m (voir schéma page 11)

Coloris

Structure:



Blanc 9010 mat



Gris 7016 sablé



Sur mesure
uniquement structure
(selon RAL disponible p.6)

Lames:



Blanc 9010 mat

Options



Eclairage couleur par bandeau LED



Store zippé enroulable manuel

Photos non contractuelles

DES PROFILS ROBUSTES ET ESTHETIQUES :

Cadre

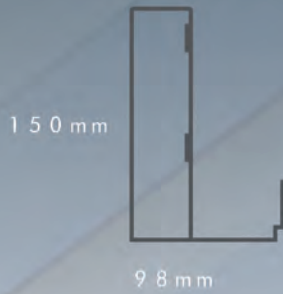

EP. 2,5 mm

Poteau



EP. 4 mm

Lame

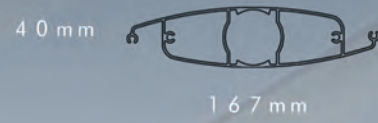

EP. 1,5 mm

FIXATION MURALE

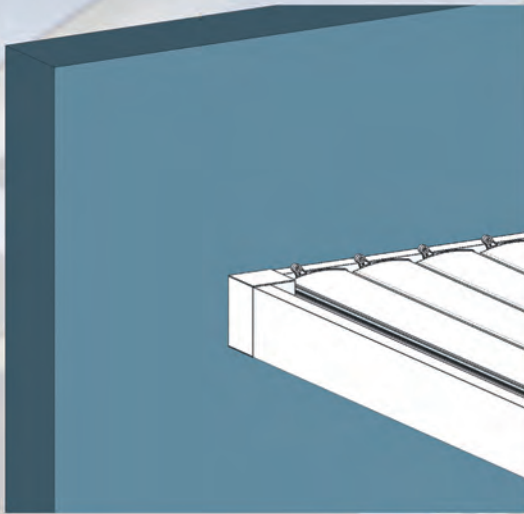

FIXATION DE POTEAUX invisible



FIXATION DE POTEAUX Semi-débordante



Les 2 types de fixation sont incluses dans toutes nos pergolas Marbella

EXEMPLES DE CONFIGURATION :



4,13 x 3,50m
Autoportante



5,18 x 3,50m
Autoportante

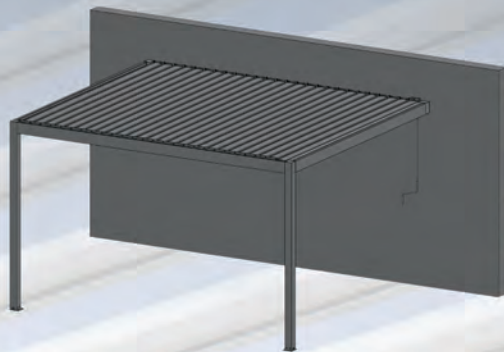

4,13 x 3,50m
Murale

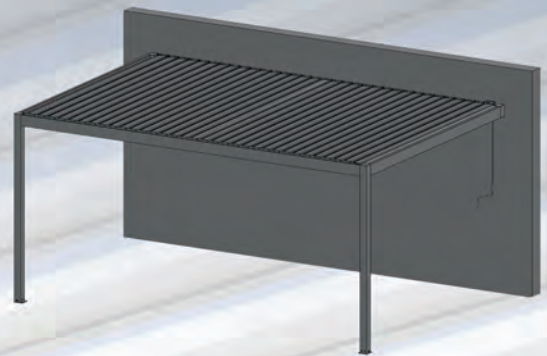

5,18 x 3,50m
Murale

Hauteur : 2,50m Hauteur lames ouvertes/hors tout: 2,56m

EXEMPLES D'ASSEMBLAGE

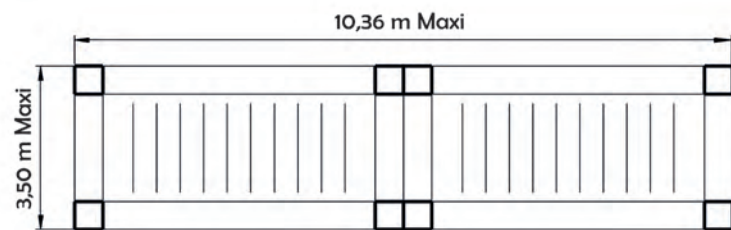
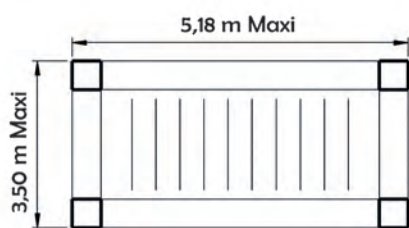

LES OPTIONS :

Eclairage LED



LED RGB 230/24 V

Structure : Flexible

Puissance : 14,4 watts/mètre
4000 K
1270 lm

Indice de protection : IP67



Télécommande avec roue chromatique

- Radio Fréquence
- IP 44
- Contrôle des couleurs tactile
- Réglage de l'intensité

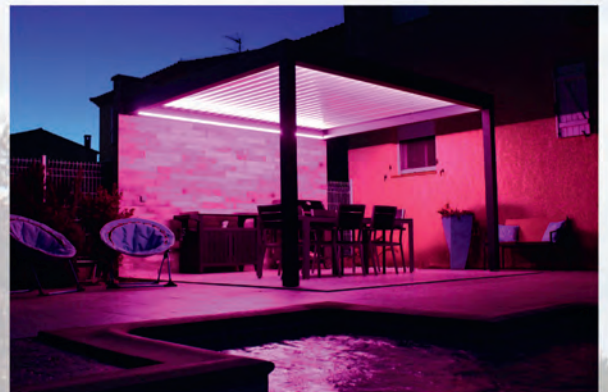
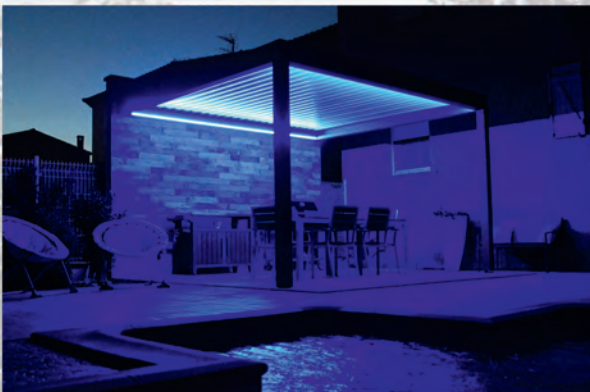

LES OPTIONS :

Store zippé manuel 



Grammage de la toile : 525g/m²

Epaisseur : 0,75mm

Température : -30°C / +70°C

Coloris



Gris clair



Gris foncé



Blanc

Store façade en 2 parties avec poteau intermédiaire pour les pergolas d'une largeur supérieur à 4200mm (hors tout)

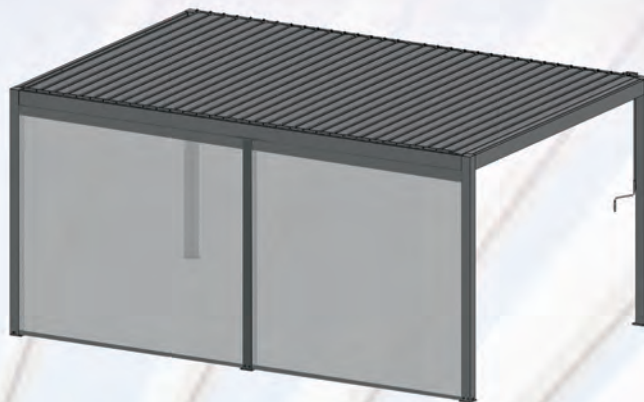

Cales de réglages

Vous permet de mettre votre pergola de niveau

Disponible en lots de 6 cales :

- 6 cales de 5mm
- 6 cales de 10mm

Hauteur de calage Max : 30mm

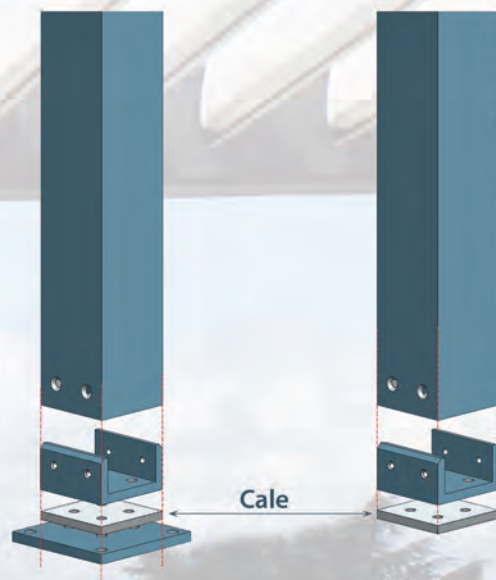



CSTB

le futur en construction

Pour s'assurer de la robustesse de notre gamme Panama, nous avons réalisé des tests dans la soufflerie Jules Verne du CSTB de Nantes ; selon le rapport d'expertise ENCAPE 17-059CV1

Panama autoportante :
5 x 3.3m

- Essai pluie
- Essais Vent

Le Bioclimatique haut de gamme



Protection contre les rayons du soleil et la pluie



Par temps frais, Laissez entrer la chaleur



Evacuez la chaleur, pour éviter un effet de serre

Manoeuvre des lames

Par vérin électrique et télécommande



Cache-vérin

Dimensions

- Standards : - 3x3x2,5 mètres
 - 4,05x3x2,5 mètres
 - 6x3x2,5 mètres
- (Murale ou Autoportante)

Sur mesure max: 6x6m sans poteau intermédiaire
possibilité d'assembler plusieurs Panama
hauteur max: 3m (Voir schéma p.17)

Coloris

- | | | |
|------------|---|--|
| Structure: | <input type="checkbox"/> Blanc 9010 mat | <input type="checkbox"/> Gris 7016 sablé |
| Lames: | <input type="checkbox"/> Blanc 9010 mat | Sur mesure
(selon RAL disponible p.6) |

Options



Eclairage couleur par bandeau LED

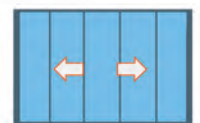

Paroi coulissante verre



Capteur vent/pluie/neige/gel

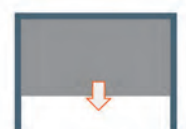

Store zippé enroutable motorisé

DES PROFILS ROBUSTES ET ESTHÉTIQUES :

Cadre

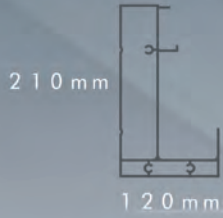

EP. 2,5 mm

Poteau



EP. 5 mm

Closoir poteau



EP. 1,5 mm

Lame

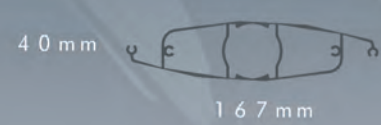

EP. 1,5 mm

Nous assurons l'étanchéité entre lames à l'aide de deux joints (epdm) Une légère pente assure l'évacuation de l'eau vers les poteaux

FIXATION MURALE

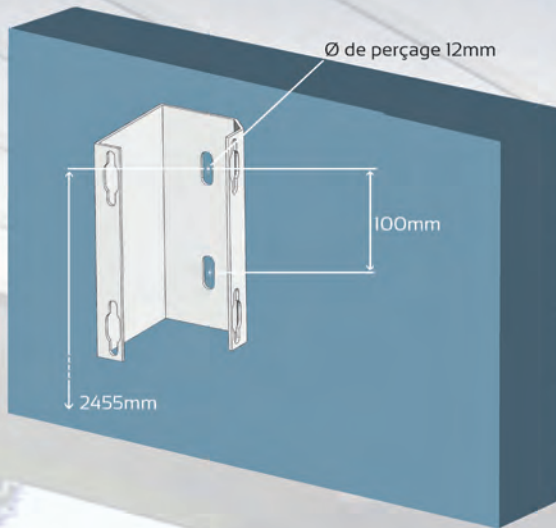

FIXATION DES POTEAUX

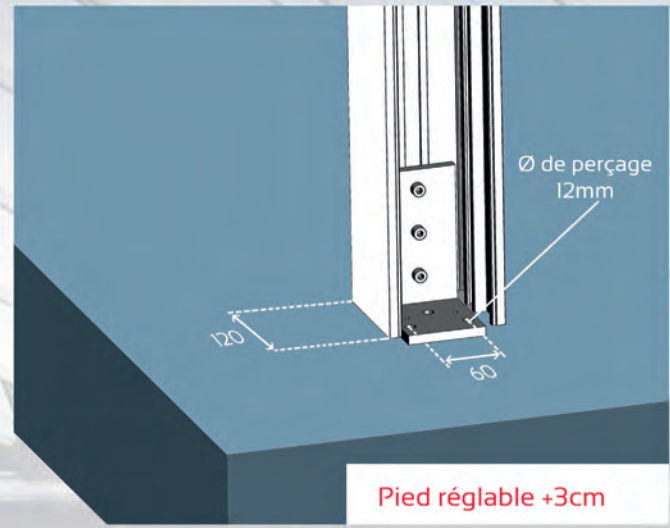

Télécommande

- Nombre de canaux : 6
- Possibilité de pilotage :
 - Ouverture / fermeture des lames
 - Eclairage LED
 - Store

Si plusieurs rangées de lames ou modules, vous pouvez créer des scénarios.

Par exemple : 1 canal pour les lames avant, 1 pour les lames arrières et 1 pour l'ensemble des lames.

EXEMPLES DE CONFIGURATION :

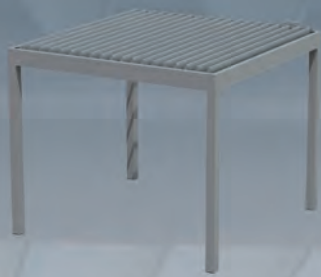

3 x 3 m
Autoportante



4,05 x 3 m
Autoportante

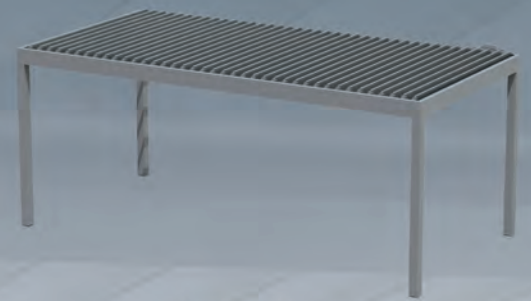

6 x 3 m
Autoportante



3 x 3 m
Murale

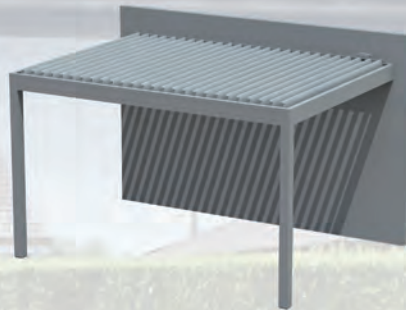

4,05 x 3 m
Murale

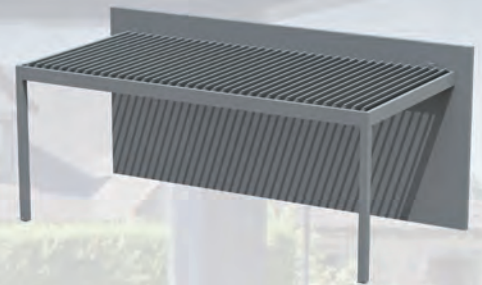

6 x 3 m
Murale

Hauteur : 2,50m Hauteur lames ouvertes : 2,56m Hauteur hors tout : 2,64m

EXEMPLES D'ASSEMBLAGE

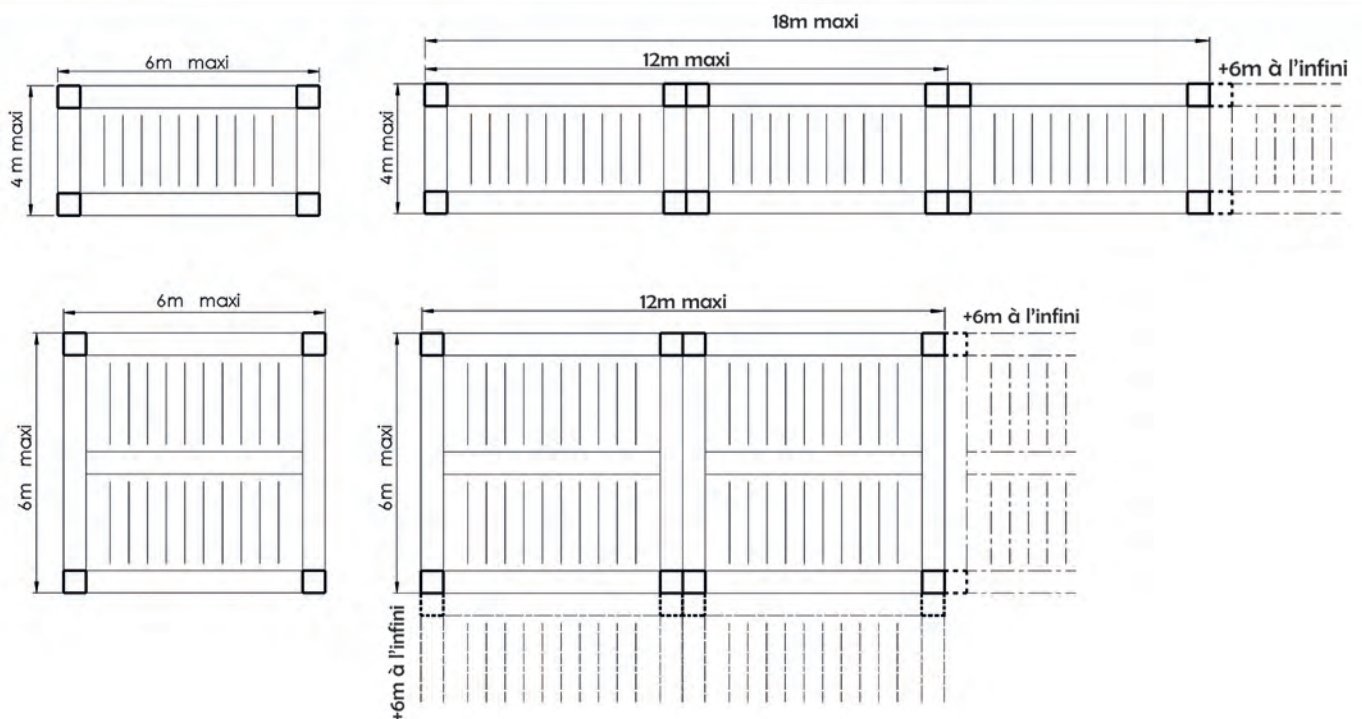

LES OPTIONS :

Eclairage LED



LED RGB 230/24 V

Structure : Flexible

Puissance : 14,4 watts/mètre
4000 K
1270 lm

Indice de protection : IP67

Utilisation via télécommande de la pergola

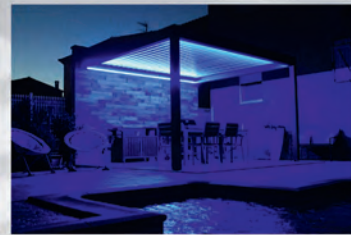
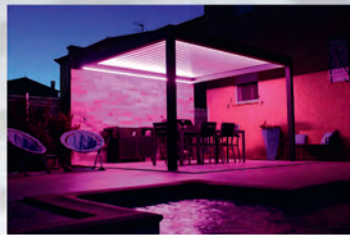

Position des bandeaux LED

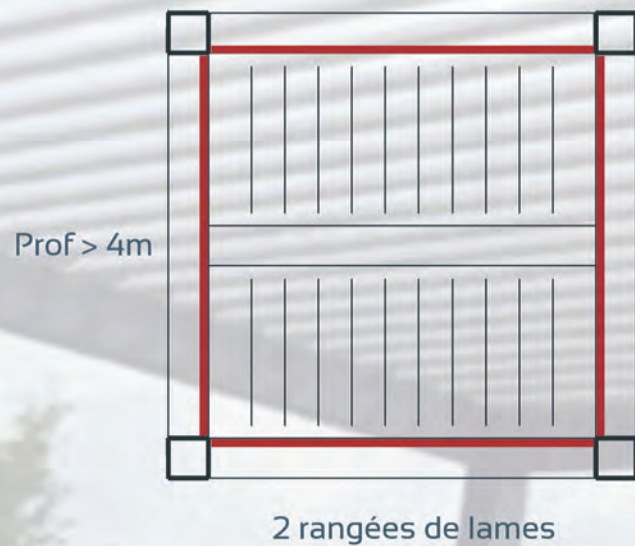
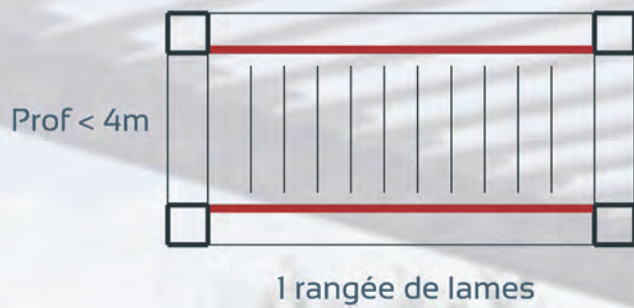

Capteur Météo



Permet de gérer l'orientation des lames en fonction du vent, de la pluie, de la neige et du gel.

Cette option comprend :



Capteur de vent



Capteur de pluie



Capteur de température

LES OPTIONS :

Store zippé



Grammage de la toile : 525g/m²

Epaisseur : 0,75mm

Température : -30°C / +70°C

Coloris



Gris clair



Blanc



Gris foncé

Store façade en 2 parties avec poteau intermédiaire pour les pergolas d'une largeur supérieure à 4240mm (hors tout)

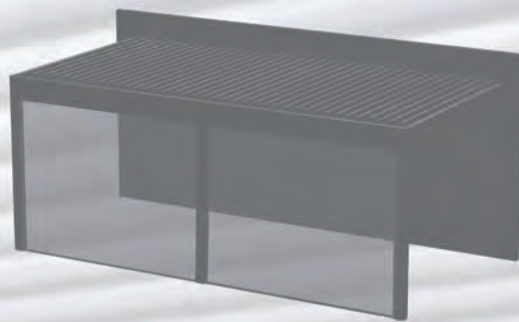

Télécommande pour bandeau LED

Les stores se manipulent à l'aide de la télécommande de la pergola.

Réglage sur les différents canaux.

Parois vitrées



Verre trempé de 10 mm

5 parois coulissantes

5 panneaux en verre trempé 10 mm.
Les panneaux coulissent sur un rail bas en aluminium anodisé et sont guidés par un second rail haut avec loqueteau de fermeture droit et gauche.

QUELQUES REALISATIONS





Photos non contractuelles



Pergola Castille

Pergola à toit fixe

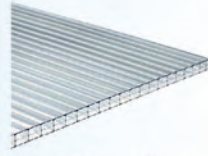

Polycarbonate
alvéolaire opaque 16mm

ou



Panneaux isolés
blanc 16mm

Dimensions

Standards : - 3,71x3x2,51 mètres
- 4,92x3,08x2,51 mètres
- 6,13x3,08x2,51 mètres

(Murale ou Autoportante)

Pas de sur mesure possible

Coloris standards



Structure:

Blanc 9010 mat



Gris 7016 sablé

Options



Store **zippé**
enroulable manuel

DES PROFILS ROBUSTES ET ESTHETIQUES :

Cadre



EP. 2,5 mm

Poteau



EP. 4 mm

Coiffe+2 joints



Panne

60 mm

EP. 3 mm

FIXATION MURALE

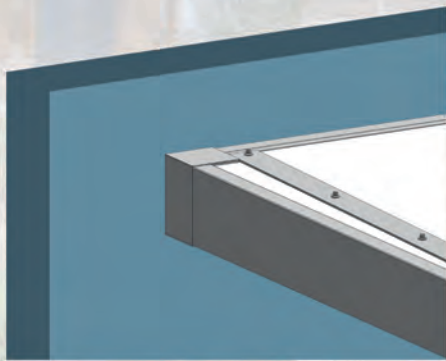

FIXATION DES POTEAUX

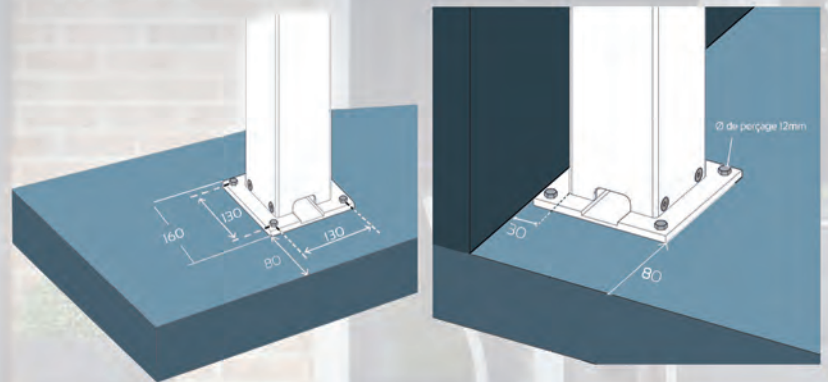

OPTIONS



Store zippé
enroulable
par manivelle

Grammage de la toile 585g/m²
Epaisseur 0,74mm
Température -30°C / + 70°C

Coloris standards:

 Gris clair

Coloris avec délais supplémentaire:

 Blanc

 Gris foncé



EXEMPLES DE CONFIGURATION :



3,71 x 3,08m
Autoportante



4,92 x 3,08m
Autoportante



6,13 x 3,08m
Autoportante



3,71 x 3,08m
Murale



4,92 x 3,08m
Murale



6,13 x 3,08m
Murale

Hauteur hors tout : 2,51m

NOS REALISATIONS



Photos non contractuelles

Tableau de synthèse pergola

	Pergola Marbella	Pergola Panama	Pergola Castille
Livraison domicile	●	●	●
Toiture			
Polycarbonate alvéolaire opaque			●
Panneaux isolés blanc			●
Lames			
Orientation des lames	●	●	
Manoeuvre des lames	manuelle	motorisée	
Version de pose			
Murale	●	●	●
Autoportante	●	●	●
Dimensions			
4,13 x 3,50	●		
5,18 x 3,50	●		
3 x 3		●	
4,05 x 3		●	
6 x 3		●	
3,71 x 3,08			●
4,92 x 3,08			●
6,13 x 3,08			●
Sur mesure	●	●	
Coloris Structure			
Gris 7016 sablé	●	●	●
Blanc 9010 mat	●	●	●
Sur mesure		●	
Coloris lames			
Blanc 9010 mat	●	●	
Sur mesure	●	●	
En Options			
Store zip manuel	●		●
Store zip motorisé		●	
Eclairage LED	● RGB	● RGB	
Paroi coulissante verre		●	
Capteur Météo (vent, pluie, neige, gel)		●	
Configurateur en ligne			
Dimensions standards	●	●	
Dimensions sur-mesure	jusque 10,36 x 3,5m	jusque 12 x 6m	
Eclairage LED	●	●	
Store zip	●	●	
Capteur Météo		●	



Retrouvez-nous également sur notre site internet

www.oriasun.fr

Fiches Techniques



Vidéos





PERGOLA PANAMA

5 Structure garantie 5 ans 2 Pièces d'usure garanties 2 ans

CONFIGURATION DE LA PERGOLA

I : CHOISISSEZ VOTRE STRUCTURE :



Murale



Autoportante

II : ENTREZ LES DIMENSIONS SOUHAITÉES

HAUTEUR : max : 3000
LARGEUR : max : 12000
PROFONDEUR : max : 8000

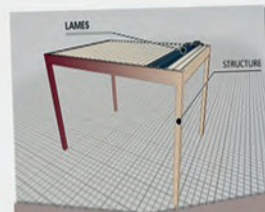

COLORIS DE STRUCTURE STANDARDS :

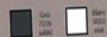

AUTRES RAL (STRUCTURE ET/OU LAMES) :

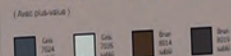

III : CHOISISSEZ LA COULEUR :

De votre structure :

- GRIS 7010 SABLE
- BLANC 9010 MAT
- AUTRE RAL

De vos lames :

- BLANC 9010 MAT
- AUTRE RAL

- 1** Connectez vous sur www.oriasun.fr
- 2** Cliquez sur espace revendeur
- 3** Entrez les dimensions de la pergola
- 4** Choisissez la couleur de la structure
- 6** Sélectionnez les options
- 7** Obtenez un devis et un plan

NOTRE GAMME DE CARPORTS

**Abritez vos véhicules
grâce à nos carports
aluminium**







Choisissez votre toiture :

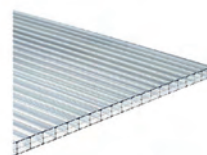

Polycarbonate
alvéolaire opale 16mm

ou

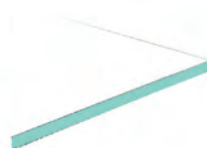

Panneaux isolés
blanc 16mm

Dimensions

Standards : - 4,92 x 3,08 x 2,51 mètres
- 6,13 x 3,08 x 2,51 mètres

(Murale ou Autoportante)

Pas de sur mesure possible

Coloris standards

Structure:



Blanc 9010 mat



Gris 7016 sablé

DES PROFILS ROBUSTES ET ESTHETIQUES :

Cadre

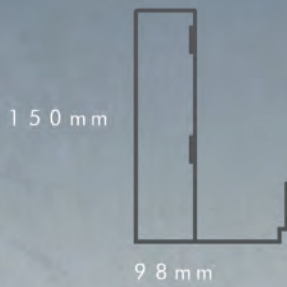

EP. 2,5 mm

Poteau



EP. 4 mm

Coiffe+2 joints

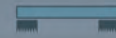

Panne



EP. 3 mm

FIXATION MURALE

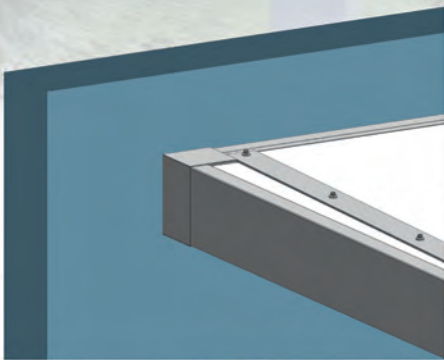

FIXATION AUTOPORTANTE

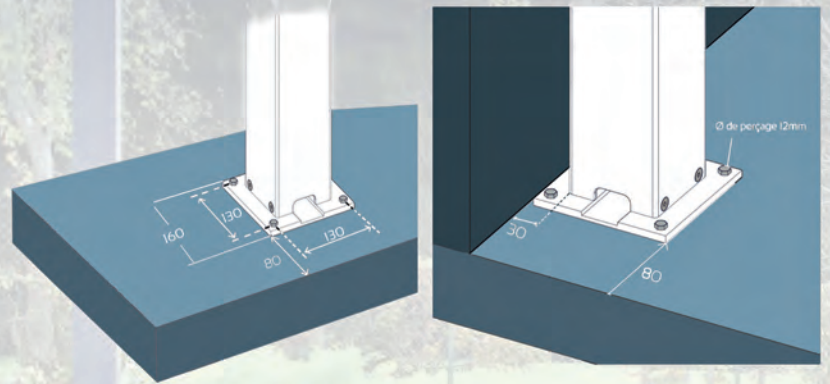

EXEMPLES DE CONFIGURATION :



4,92 x 3,08m
Autoportante



6,13 x 3,08m
Autoportante



4,92 x 3,08m
Murale



6,13 x 3,08m
Murale

Dimensions de passage pour votre véhicule:

Longueur : 4,92m Largeur : 2,88m /3,01(murale)
Longueur : 6,13m Largeur : 2,88m /3,01(murale)

Hauteur : 2,36m Hauteur (hors tout) : 2,51m
Hauteur : 2,36m

NOS REALISATIONS



Photos non contractuelles



Carport C210

Choisissez votre toiture :

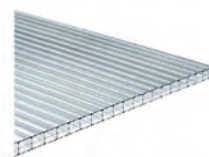

Polycarbonate
alvéolaire opale 16mm

ou



Panneaux isolés
blanc 16mm

Dimensions

Standards : - 5,15x3 mètres
- 6,36 x 3 mètres

(Murale ou Autoportante)

**Sur mesure possible
hauteur 3m Max.**

Coloris standards

Structure:



Blanc 9010 mat



Gris 7016 sablé

Options



Eclairage blanc
avec détecteur
de présence



Paroi arrière
aluminium



Paroi latérale
aluminium

Photos non contractuelles

DES PROFILS ROBUSTES ET ESTHETIQUES :

Cadre



EP. 2,5 mm

Poteau

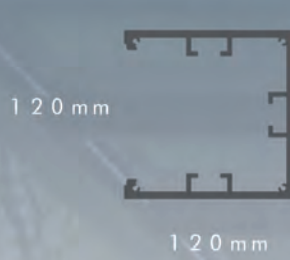

EP. 5 mm

Coiffe+2 joints



Panne

60 mm

EP. 3 mm

FIXATION MURALE

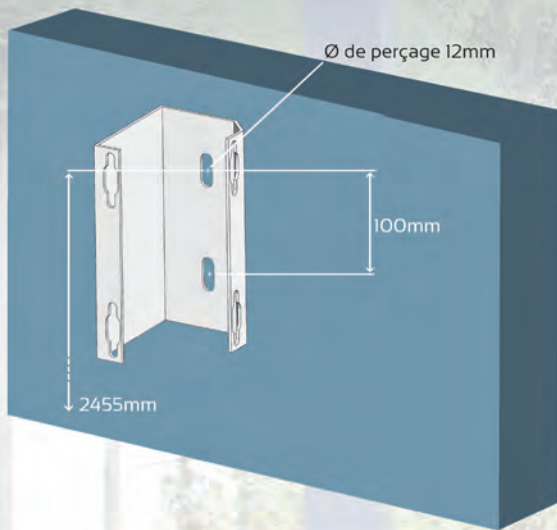

FIXATION AUTOPORTANTE

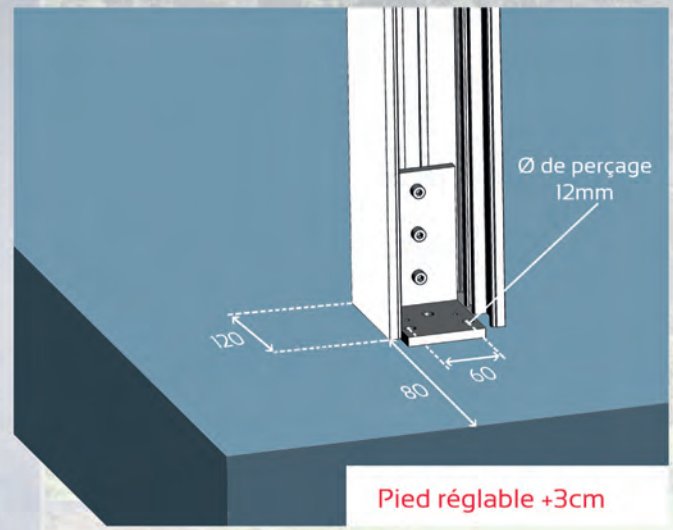

OPTIONS



Eclairage avec détecteur de présence

IP 65

Puissance : 12W

Blanc neutre 4000k



Paroi arrière aluminium

100 % Aluminium

2 types de lames :

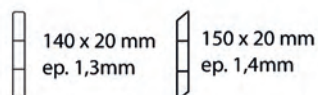

Paroi latérale aluminium

100 % Aluminium

2 types de lames :

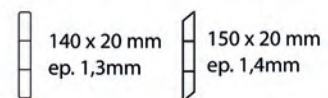

EXEMPLES DE CONFIGURATIONS :



5,15 x 3m
Autoportante



6,36 x 3m
Autoportante



5,15 x 3m
Murale

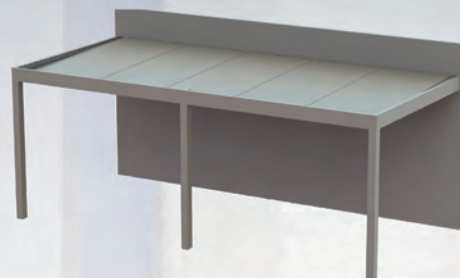

6,36 x 3m
Murale

Dimensions de passage pour votre véhicule:

C210 5,15m : Largeur : 2,76m / 2,88 (murale)

C210 6,36m : Largeur : 2,76m / 2,88 (murale)

Hauteur : 2,29m

Hauteur : 2,51m

Hauteur : 2,29m





Carport C210 + local

Choisissez votre toiture :

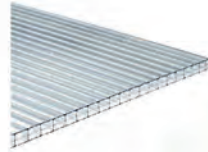

Polycarbonate
alvéolaire opale 16mm

ou



Panneaux isolés
blanc 16mm



Dimensions

6,36 x 3 mètres
Autoportant uniquement
Hauteur: 2,50m

Dimensions de passage pour votre véhicule :

Longueur : 5,15m
Largeur : 2,76m
Hauteur : 2,29m

Coloris standards



Structure: Gris 7016 sablé

Options



Eclairage blanc
avec détecteur
de présence



Paroi latérale
aluminium

Photos non contractuelles

Tableau de synthèse carport

	Carport C-150	Carport C-210	Carport C-210 avec local technique
Livraison domicile	●	●	●
Toiture			
Polycarbonate alvéolaire opaque	●	●	●
Panneaux isolés blanc	●	●	●
Version de pose			
Murale	●	●	
Autoportante	●	●	●
Dimensions			
4,92 x 3,08 mètres	●		
6,13 x 3,08 mètres	●		
5,15 x 3 mètres		●	
6,36 x 3 mètres		●	●
Sur mesure		●	
Coloris Structure			
Gris 7016 sablé	●	●	●
Blanc 9010 mat	●	●	
En Options			
Eclairage avec détecteur de présence		●	●
Paroi aluminium arrière		●	
Paroi aluminium latérale		●	●



Retrouvez les présentations et vidéos de montages de nos produits sur notre chaîne youtube : Oriasun

Chiffrez directement votre chantier



Si vous n'avez pas encore accès à notre bibliothèque, envoyez votre demande service-commercial@orialpro.fr





Brise soleil

Dimensions

1440 x 751 mm ou 2860 x 751mm en standard



Longueur sur mesure possible à l'infini
en assemblant les modules

Coloris standards



Structure: Gris 7016 sablé



Sur mesure
(selon RAI page.6)

Caractéristiques :

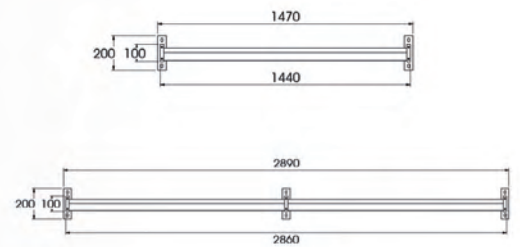

Nos réalisations



Photos non contractuelles

Notre équipe commerciale

Besoin d'un conseil, d'un devis ou autres ?
Contactez un de nos collaborateurs ci-dessous.

Service commercial



service-commercial@orialpro.fr



03.23.91.35.63

Service Devis



devis@orialpro.fr



03.60.48.15.01

Service après-vente



sav@orialpro.fr



03.60.73.60.04

Une équipe de commerciaux terrain est à votre disposition :
consultez-nous pour leurs coordonnées

Conditions commerciales

Frais de port:

Franco à partir de 1 500 euros d'achat HT
De 0 à 1 499€ d'achat HT, frais de port de 70€ HT

Frais administratifs:

Des frais de 30€ HT seront appliqués pour toutes commandes < 300€ HT d'achat



CARPORTS



BRISE - SOLEIL

Retrouvez aussi notre gamme



Oriabal
www.oriabal.fr

125 rue de guise
02500 HIRSON
France

Téléphone : +33(0)3 23 91 35 63

Site : www.oriasun.fr

Mail : service-commercial@orialpro.fr

