



NOUVELLES FERMETURES INTERNATIONAL
2012-2022

EXTENSION DE MAISON HOUSE EXTENSION



ZA Cantone Voie N°3
20260 - CALVI

Tél : 04 95 31 82 89

Email : contact@bmc.corsica



FR|EN_V2_24/10_2022



003
PERGOLA
PERGOLA

- 005 Pergola Polycarbonate**
Pergola Polycarbonate
- 013 Pergola Toile**
Pergola Shade Cloth
- 021 Pergola Bioclimatique**
Pergola Bioclimatic
- 033 Store Vertical**
Vertical Blind
- 035 Store Vertical Zip**
Vertical Blind Zip
- 037 Rideau de Verre**
Glass Curtain
- 039 Cloison de claire voie**
Privacy Screen

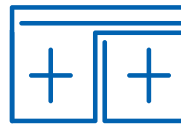

041
VERANDA
GLASS ROOM

- 043 Veranda**
Glass room
- 047 Jardin d'Hiver Contemporain**
Winter Garden Contemporain
- 049 Jardin d'Hiver Classic**
Winter Garden Classic

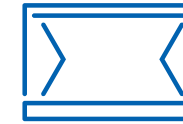

051
STORE-BANNE
AWNING



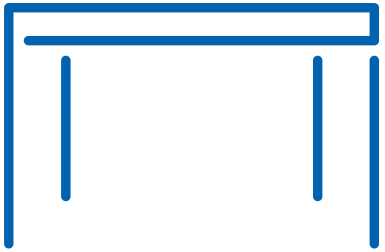

PERGOLA

PERGOLA

005 Pergola Polycarbonate
Pergola Polycarbonate

013 Pergola Toile
Pergola Shade Cloth

021 Pergola Bioclimatique
Pergola Bioclimatic

033 Store Vertical
Vertical Blind

035 Store Vertical Zip
Vertical Blind Zip

037 Rideau de Verre
Glass Curtain

039 Cloison de claire voie
Privacy Screen



P. POLYCARBONATE
P. POLYCARBONATE
SUNDAY

Caractéristiques | Characteristics

- Poteau et faitière 120x64mm
- Gouttière 93x141mm
- Chevron 80x40mm
- Aluminium thermolaqué Qualicoat / Qualimarine / Qualanod
- Polycarbonate translucide 16mm traité anti UV avec obturateur poly, adhésif microperforé, en option polycarbonate 32mm
- Platine de fixation au sol
- Vis de fixation fournies
- Bouchon de récupération des eaux de pluie inclus
- Posts and beams 120x64mm
- Rain gutter 93x141mm
- Rafters 80x40mm
- Powder coated aluminum Qualicoat / Qualimarine / Qualanod
- Polycarbonate translucent 16mm treated anti UV with poly shutter, adhesive microperforated, as optional 32mm
- Floor mounting plate
- Fixing screws provided
- Rainwater recovery cap included

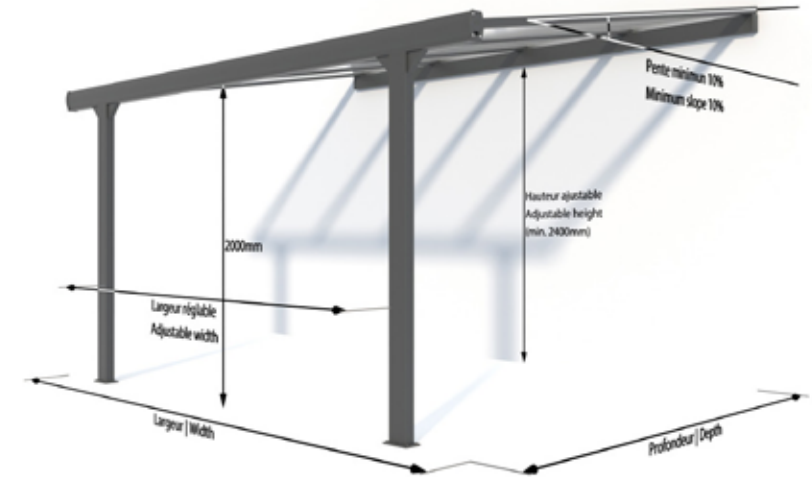
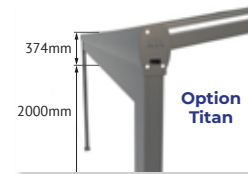
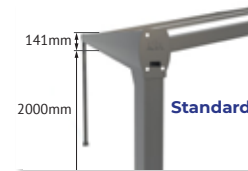

Résistance au VENT
Resistance to WIND

C6

CE

Certifié ENAC - Laboratoire ENSATEC - CE NB 1668 n° de organisme notifié Classement - VENT C6 EN 13561

Certified ENAC - Laboratory ENSATEC - CE NB 1668 notified entity number Ranking - WIND C6 EN 13561

Chevron d'extrémité
End Rafters

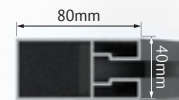

Chevron intermédiaire
Middle Rafters

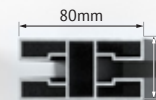

Gouttière
Rain Gutter



Poteau
Post



Platine au sol
Floor Plate





P. POLYCARBONATE
P. POLYCARBONATE
SUNVISOR

Caractéristiques | Characteristics

- Possibilité de sur mesure
- Poteau et faitière 120x64mm
- Gouttière 93x141mm
- Chevron 80x40mm
- Aluminium thermolaqué Qualicoat / Qualimarine / Qualanod
- Polycarbonate translucide 16mm traité anti UV avec obturateur poly, adhésif microperforé
- Platine de fixation au sol
- Bouchon de recuperation des eaux de pluie inclus
- Custom possibility
- Posts and beams 120x64mm
- Gutter 93x141mm
- Rafters 80x40mm
- Powder coated aluminum Qualicoat / Qualimarine / Qualanod
- Polycarbonate translucent 16mm treated anti UV with poly shutter, adhesive microperforated
- Floor mounting plate
- Rainwater recovery cap included

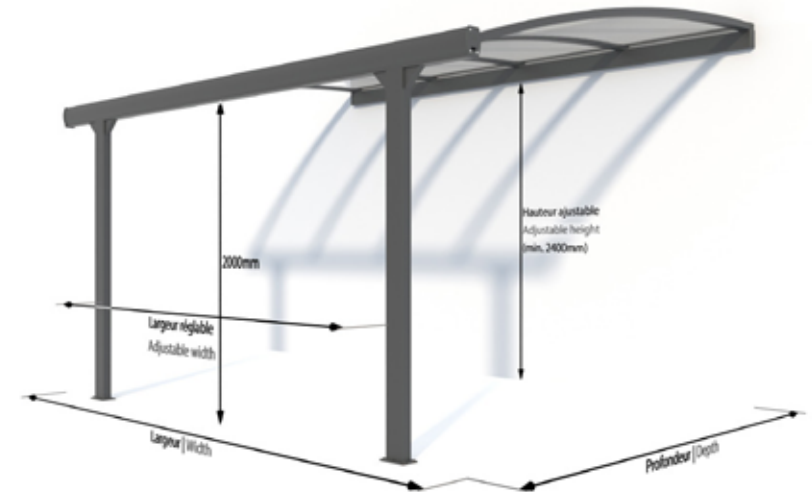
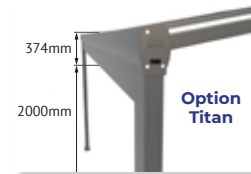
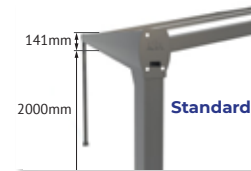

Résistance au VENT
Resistance to WIND

C6



Certifié ENAC - Laboratoire ENSATEC -
CE NB 1668 n° de organisme notifié
Classement - VENT C6
EN 13561

Certified ENAC - Laboratory ENSATEC -
CE NB 1668 notified entity number
Ranking - WIND C6
EN 13561

Chevron d'extrémité
End Rafters

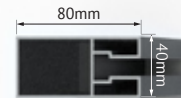

Chevron intermédiaire
Middle Rafters

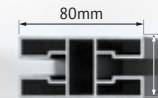

Gouttière
Rain Gutter



Poteau
Post



Platine au sol
Floor Plate





P. POLYCARBONATE
 P. POLYCARBONATE

SUNRISE DOUBLE PAN

Caractéristiques | Characteristics

- Existe en adossé et autoportant
- Poteau 154x154mm
- Poutre gouttière 260x150mm
- Chevron 80x45mm
- Inclinaison cachée double pente
- Aluminium thermolaqué Qualicoat / Qualimarine / Qualanod
- Platine de fixation au sol
- Panneau de polycarbonate translucide 16mm traité anti UV avec obturateur poly, adhésif microperforé
- Available as lean to and freestanding
- Posts 154x154mm
- Gutter beam 260x150mm
- Rafters 80x45mm
- Hidden double slope
- Powder coated aluminum Qualicoat / Qualimarine / Qualanod
- Floor mounting plate
- Translucent polycarbonate panel 16mm treated anti UV with poly shutter, microperforated adhesive

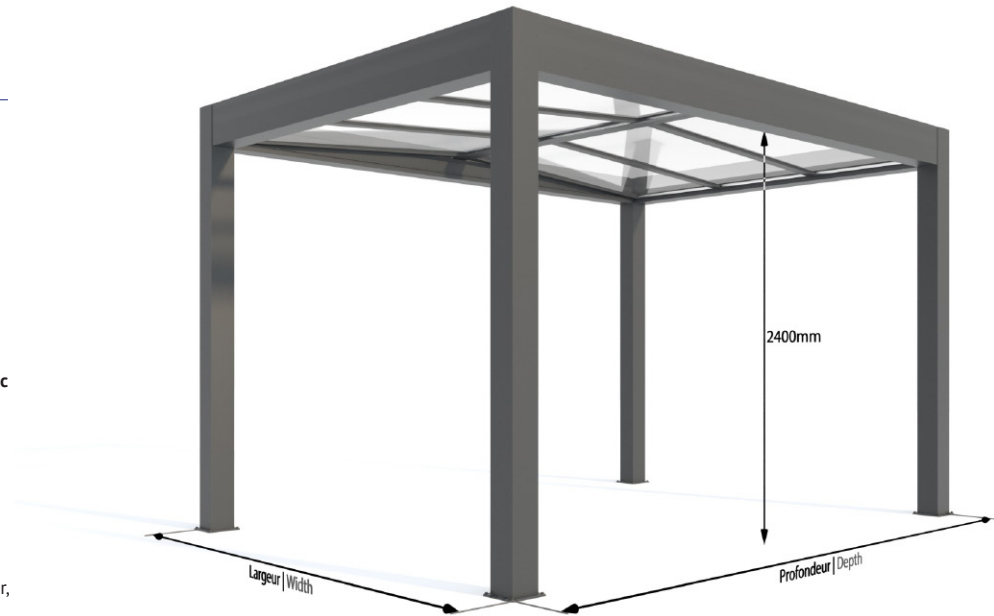

Résistance au VENT
 Resistance to WIND

C5

CE

Certifié ENAC - Laboratoire ENSATEC -
 CE NB 1668 n° de organisme notifié
 Classement - VENT C5
 EN 13561

Certified ENAC - Laboratory ENSATEC -
 CE NB 1668 notified entity number
 Ranking - WIND C5
 EN 13561

Chevron d'extrémité
End Rafters

Chevron intermédiaire
Middle Rafters

Poutre Gouttière
Beam Rain Gutter

Poteau
Post

Platine au sol
Floor Plate



P. POLYCARBONATE
P. POLYCARBONATE

SUNRISE MONO PAN

Caractéristiques | Characteristics

- Existe en adossé seulement
- Poteau 100x100mm et Poutre gouttière 288x100mm ou 438x100mm
- Chevron 80x40mm
- Inclinaison cachée mono pente
- Aluminium thermolaqué Qualicoat / Qualimarine / Qualanod
- Platine de fixation au sol
- Panneau de polycarbonate translucide 16mm traité anti UV avec obturateur poly, adhésif microperforé
- Available only as lean to
- Posts 100x100mm and Gutter beam 288x100mm or 438x100mm
- Rafters 80x40mm
- Hidden one slope
- Powder coated aluminum Qualicoat / Qualimarine / Qualanod
- Floor mounting plate
- Translucent polycarbonate panel 16mm treated anti UV with poly shutter, microperforated adhesive

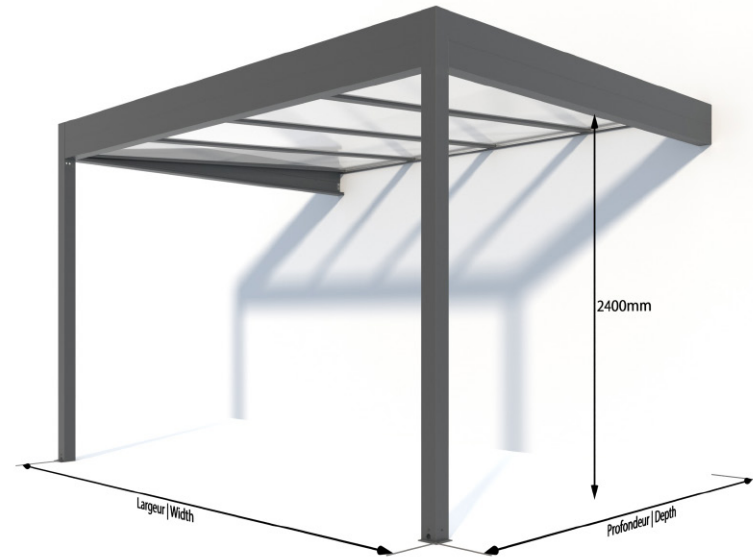

Poutre Gouttière
Beam Rain Gutter

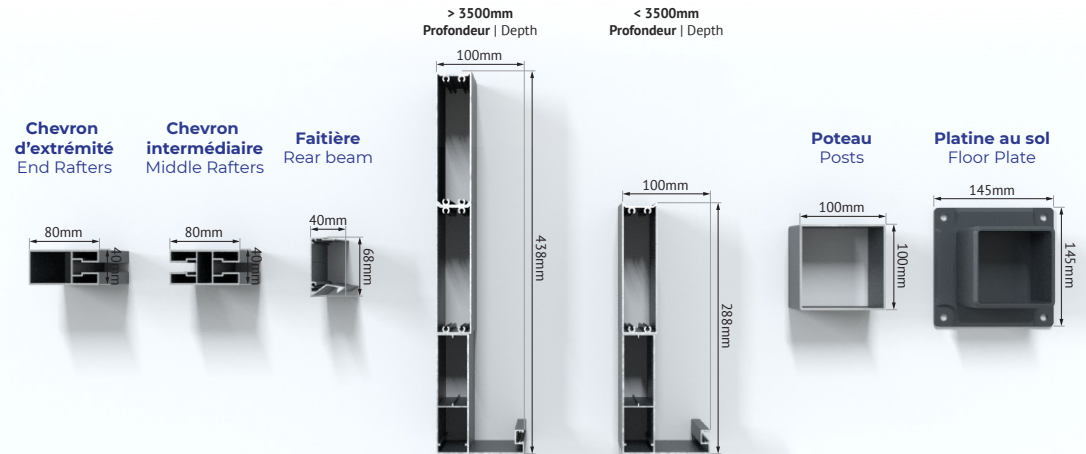

Résistance au VENT
Resistance to WIND

C5

CE

Certifié ENAC - Laboratoire ENSATEC -
CE NB 1668 n° de organisme notifié
Classement - VENT C5
EN 13561

Certified ENAC - Laboratory ENSATEC -
CE NB 1668 notified entity number
Ranking - WIND C5
EN 13561



PERGOLA TOILE
PERGOLA SHADE CLOTH
SUNSHINE

Caractéristiques | Characteristics

- Poteau 100x100mm, Traverse 60x40mm
- Aluminium thermolaqué Qualicoat / Qualimarine / Qualanod
- Platine de fixation abs au sol
- Toile polyester 230grs imperméabilisée
- Posts 100x100mm, beams 60x40mm
- Powder coated aluminum Qualicoat / Qualimarine / Qualanod
- ABS floor mounting plate
- Polyester cloth 230grs waterproof

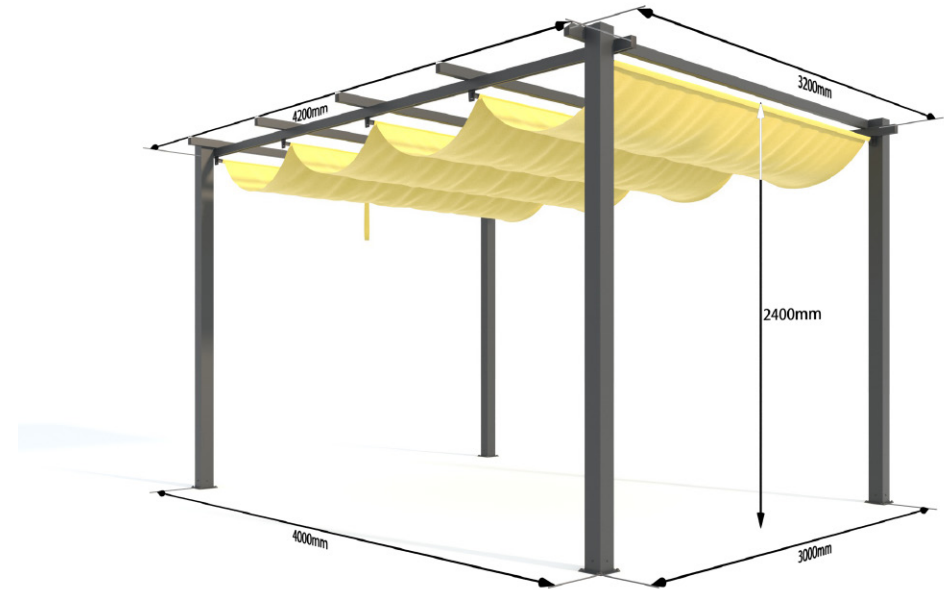

Résistance au VENT
 Resistance to WIND

C3

CE

Certifié ENAC - Laboratoire ENSATEC - CE NB 1668 n° de organisme notifié Classement - VENT C3 EN 13561

Certified ENAC - Laboratory ENSATEC - CE NB 1668 notified entity number Ranking - WIND C3 EN 13561

Traverse supérieure
 Beam high

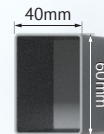

Traverse inférieure
 Beam low

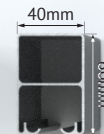

Poteau
 Posts

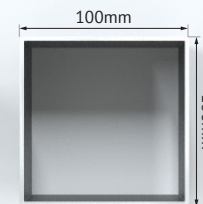

Platine au sol
 Floor Plate

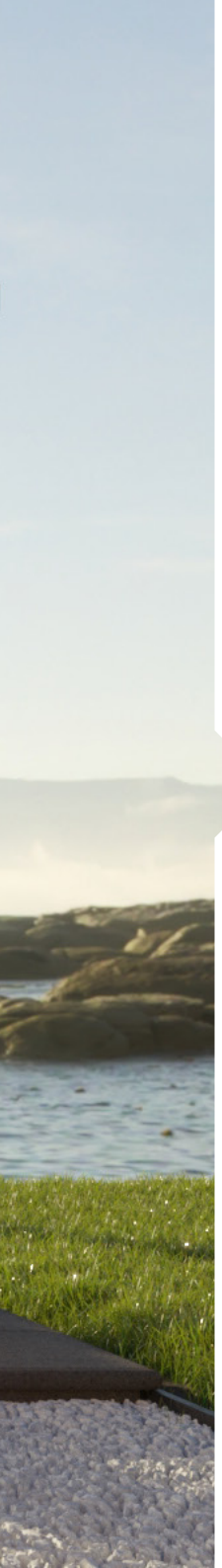
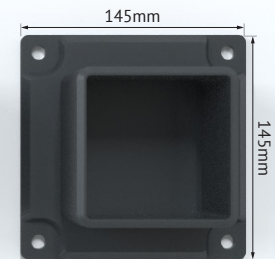



PERGOLA TOILE
PERGOLA SHADE CLOTH

SUNSET

Caractéristiques | Characteristics

- Poteau 100x100mm et Poutre gouttière 137x100mm
- Aluminium thermolaqué Qualicoat / Qualimarine / Qualanod
- Platine de fixation abs au sol
- Toile polyester 230grs imperméabilisée
- Posts 100x100mm and Gutter beam 137x100mm
- Powder coated aluminum Qualicoat / Qualimarine / Qualanod
- ABS floor mounting plate
- Polyester cloth 230grs waterproof

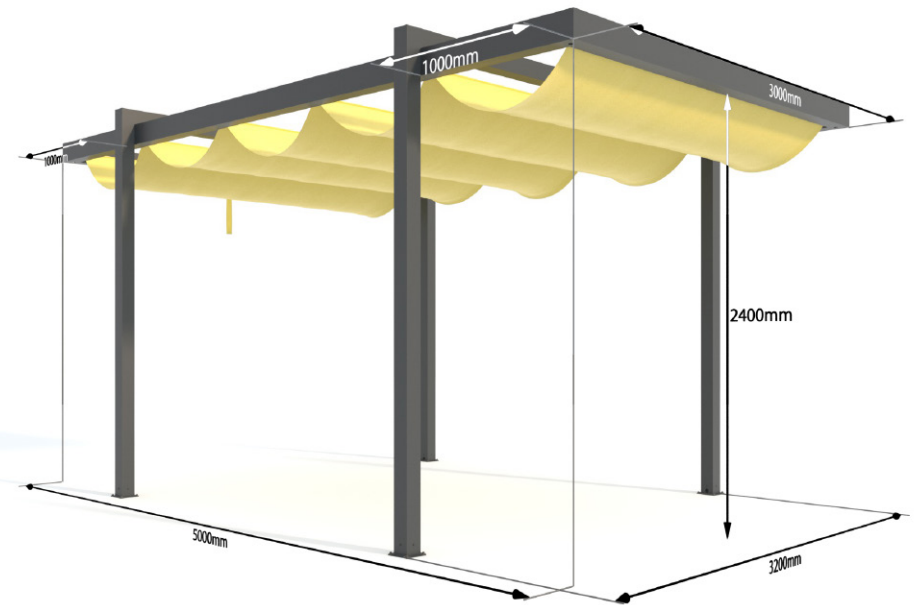

Résistance au VENT
Resistance to WIND

C2



Certifié ENAC - Laboratoire ENSATEC -
CE NB 1668 n° de organisme notifié
Classement - VENT C2
EN 13561

Certified ENAC - Laboratory ENSATEC -
CE NB 1668 notified entity number
Ranking - WIND C2
EN 13561

Gouttière
Rain gutter



Poteau
Posts

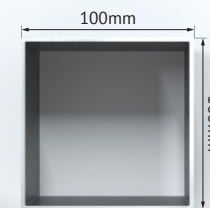

Platine au sol
Floor Plate

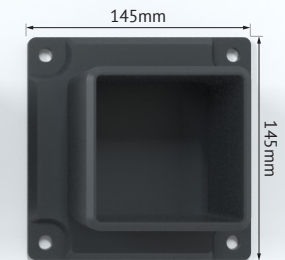



PERGOLA TOILE
 PERGOLA SHADE CLOTH

SUNLIGHT

Caractéristiques | Characteristics

- Poteau 100x100mm et Poutre gouttière 137x100mm
- Aluminium thermolaqué Qualicoat / Qualimarine / Qualanod
- Platine de fixation abs au sol
- Toile polyester 230grs imperméabilisée
- Posts 100x100mm and Gutter beam 137x100mm
- Powder coated aluminum Qualicoat / Qualimarine / Qualanod
- ABS floor mounting plate
- Polyester cloth 230grs waterproof

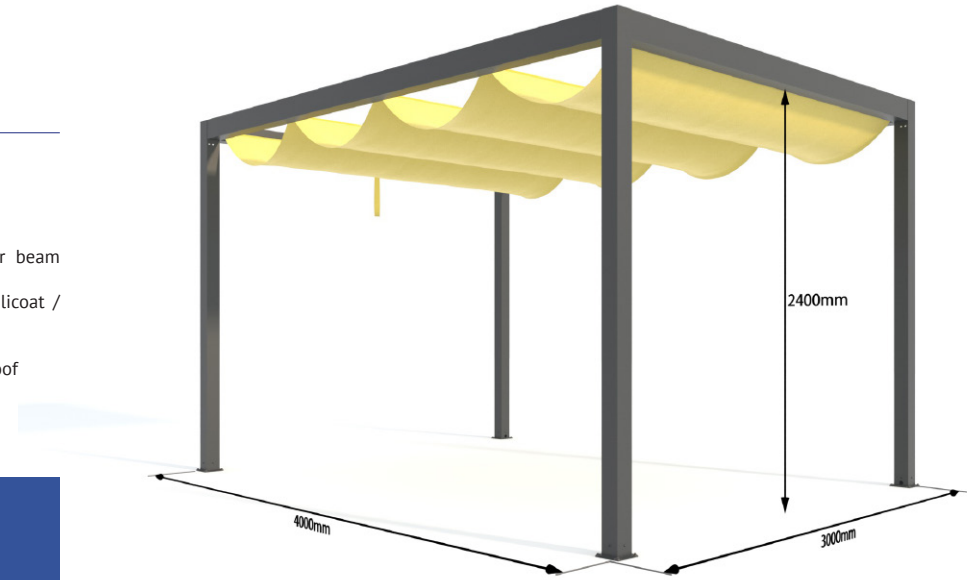

Résistance au VENT
 Resistance to WIND

C3



Certifié ENAC - Laboratoire ENSATEC -
 CE NB 1668 n° de organisme notifié
 Classement - VENT C3
 EN 13561

Certified ENAC - Laboratory ENSATEC -
 CE NB 1668 notified entity number
 Ranking - WIND C3
 EN 13561

Gouttière
 Rain gutter



Poteau
 Posts

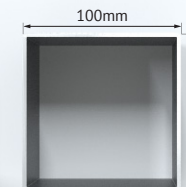

Platine au sol
 Floor Plate

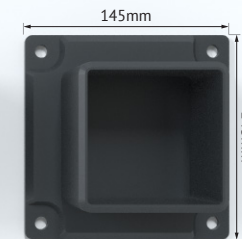



PERGOLA TOILE
PERGOLA SHADE CLOTH
SUNFLOWER

Caractéristiques | Characteristics

- Montant: 90x90mm
- Montant supérieur: 90x120mm
- Coffre de la toile:
 - Largeur supérieure du coffre: 185mm
 - Largeur inférieure du coffre: 127mm
- Montant de la toile: 112x48mm
- Aluminium thermolaqué Qualicoat / Qualimarine / Qualanod
- Toile acrylique teintée dans la masse 300g/m² pour des couleurs éclatantes et durables
- Motorisation NFI et récepteur radio avec sa télécommande individuelle
- Traitement imperméabilisant, double couture
- Platine de fixation au sol
- Vis de fixation fournies
- Post: 90x90mm
- Upper lower: 90x120mm
- Canvas box:
 - Upper box width: 185mm
 - Lower box width: 127mm
- Amount of the canvas: 112x48mm
- Qualicoat / Qualimarine / Qualanod thermo-lacquered aluminum
- 300g/m² dyed acrylic canvas for vibrant and durable colors
- NFI motor and radio receiver with individual remote control
- Waterproofing treatment, double stitching
- Floor mounting plate
- Fixing screws provided

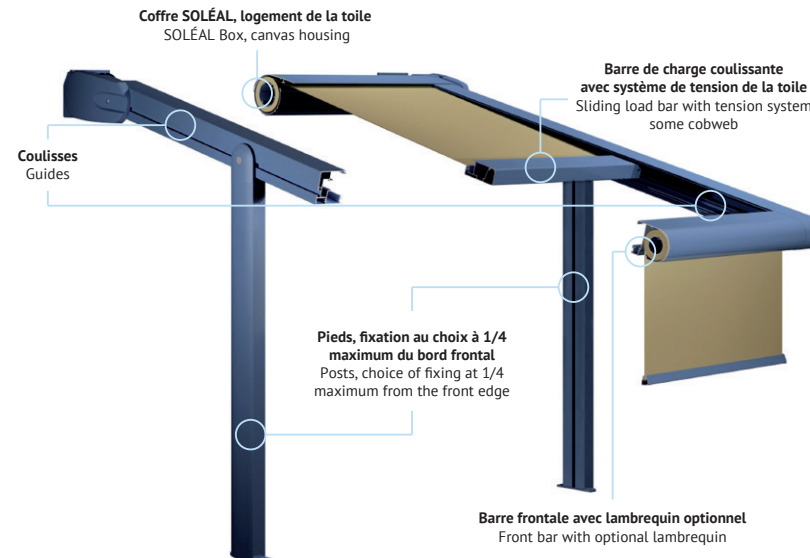

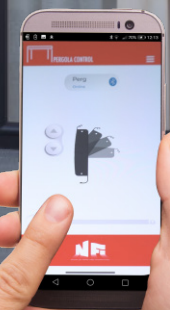

PERGOLA BIOCLIMATIQUE
 PERGOLA BIOCLIMATIC

SUNCONTROL III

Caractéristiques | Characteristics

- | | |
|---|--|
| <ul style="list-style-type: none"> - Existe en adossé et autoportant - Poteau 154x154mm - Poutre gouttière 150x260mm - Lame 211mm double parois - Automatisation à vis sans fin caché - Aluminium thermolaqué Qualicoat / Qualimarine / Qualanod - Platine de fixation au sol - Led intégrées en périphérie - Boîtier de commande invisible avec télécommande et Application mobile (Android et Apple's IOS) - Option d'agrandissement des gouttières | <ul style="list-style-type: none"> - Available as lean to and freestanding - Posts 154x154mm - Gutter beam 150x260mm - Double walled slats 211mm - Hidden worm-screw automation - Powder coated aluminum Qualicoat / Qualimarine / Qualanod - Floor mounting plate - Peripheral build-in LEDs - Invisible control box controled by remote control and smartphone app (Android and Apple's IOS) - Enlargement of gutters optional |
|---|--|



<p>Résistance au VENT Resistance to WIND</p> <p>C6 (101,61km/h)</p>	<p>Perméabilité à l'EAU Permeability to WATER</p> <p>2L (m² x min)</p>	<p>Charge de NEIGE SNOW Load</p> <p>90 kg/m²</p>
<p>Certifié ENAC - Laboratoire ENSATEC - CE NB 1668 n° de organisme notifié Classement - VENT C6 EN 13561</p> <p>Certified ENAC - Laboratory ENSATEC - CE NB 1668 notified entity number Ranking - WIND C6 EN 13561</p>		

Lame orientable renforcée
Reinforced slat swivelable



Gouttière
Rain gutter



Gouttière TITAN
Rain gutter TITAN



Poteau
Posts



Platine au sol
Floor Plate

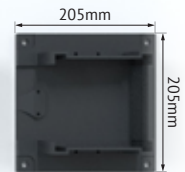

PERGOLA BIOCLIMATIQUE
 PERGOLA BIOCLIMATIC

SUNCONTROL III

OPTION SUSPENDUE

Caractéristiques | Characteristics

- Poutre gouttière 150x260mm
 - Lame 211mm double parois
 - Automatisation à vis sans fin caché
 - Aluminium thermolaqué Qualicoat / Qualimarine / Qualanod
 - Led intégrées en périphérie
 - Boîtier de commande invisible avec télécommande et Application mobile (📱Android et 🍏Apple's IOS)
 - Option d'agrandissement des gouttières
- Gutter beam 150x260mm
 - Double walled slats 211mm
 - Hidden worm-screw automation
 - Powder coated aluminum Qualicoat / Qualimarine / Qualanod
 - Peripheral build-in LEDs
 - Invisible control box controlled by remote control and smartphone app (📱Android and 🍏Apple's IOS)
 - Enlargement of gutters optional





PERGOLA BIOCLIMATIQUE
 PERGOLA BIOCLIMATIC

SUNCONTROL III
OPTION TITAN

Caractéristiques | Characteristics

- Existe en adossé et autoportant
- Poteau 154x154mm
- Poutre gouttière 150x350mm
- Lame 211mm double parois
- Automatisation à vis sans fin caché
- Aluminium thermolaqué Qualicoat / Qualimarine / Qualanod
- Platine de fixation au sol
- Led intégrées en périphérie
- Boîtier de commande invisible avec télécommande et Application mobile (Android et Apple's IOS)
- Option d'agrandissement des gouttières
- Available as lean to and freestanding
- Posts 154x154mm
- Gutter beam 150x350mm
- Double walled slats 211mm
- Hidden worm-screw automation
- Powder coated aluminum Qualicoat / Qualimarine / Qualanod
- Floor mounting plate
- Peripheral build-in LEDs
- Invisible control box controled by remote control and smartphone app (Android and Apple's IOS)
- Enlargement of gutters optional



PERGOLA BIOCLIMATIQUE
 PERGOLA BIOCLIMATIC

SUNCONTROL III TITAN, POTEAU DÉPORTÉ

Caractéristiques | Characteristics

- | | |
|--|---|
| <ul style="list-style-type: none"> - Existe seulement en adossé - Poteau 154x154mm - Poutre gouttière 150x350mm - Lame 211mm double parois - Automatisation à vis sans fin caché - Aluminium thermolaqué Qualicoat / Qualimarine / Qualanod - Platine de fixation au sol - Led intégrées en périphérie - Boîtier de commande invisible avec télécommande et Application mobile (📱 Android et 🍏 Apple's IOS) - Option d'agrandissement des gouttières | <ul style="list-style-type: none"> - Available only as lean to - Posts 154x154mm - Gutter beam 150x350mm - Double walled slats 211mm - Hidden worm-screw automation - Powder coated aluminum Qualicoat / Qualimarine / Qualanod - Floor mounting plate - Peripheral build-in LEDs - Invisible control box controlled by remote control and smartphone app (📱 Android and 🍏 Apple's IOS) - Enlargement of gutters optional |
|--|---|

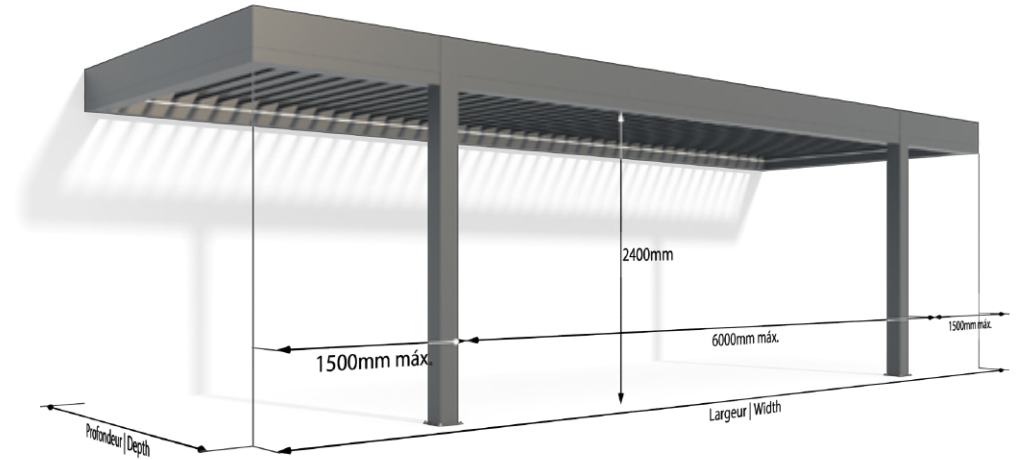

ADOSSÉE, FAÇADE
 LEAN TO, FRONT

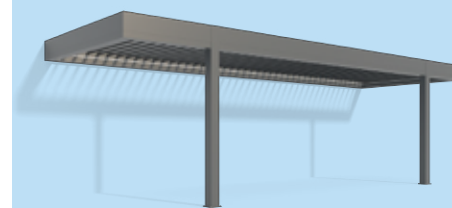

ADOSSÉE, PIGNON
 LEAN TO, SIDE

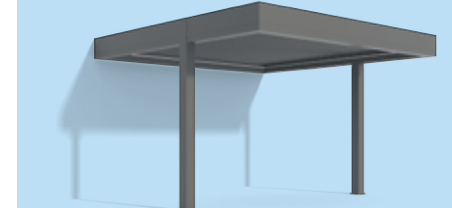

<p>Résistance au VENT Resistance to WIND</p> <p>C6 (101,61km/h)</p>	<p>Perméabilité à l'EAU Permeability to WATER</p> <p>2L (m² x min)</p>	<p>Charge de NEIGE SNOW Load</p> <p>90 Kg/m²</p>
<div style="display: flex; align-items: center; justify-content: center;"> <div style="font-size: 0.8em; line-height: 1.2;"> <p>Certifié ENAC - Laboratoire ENSATEC - CE NB 1668 n° de organisme notifié Classement - VENT C6 EN 13561</p> <p>Certified ENAC - Laboratory ENSATEC - CE NB 1668 notified entity number Ranking - WIND C6 EN 13561</p> </div> </div>		

Lame orientable renforcée
Reinforced slat swivelable



Gouttière
Rain gutter



Poteau
Posts

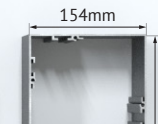

Platine au sol
Floor Plate

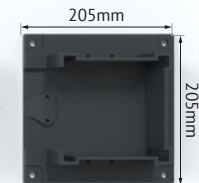



PERGOLA BIOCLIMATIQUE
 PERGOLA BIOCLIMATIC



SUNCONTROL III ARCH

Caractéristiques | Characteristics

- | | |
|--|---|
| <ul style="list-style-type: none"> - Existe en adossé et autoportant - Poteau 154x154mm - Poutre gouttière 150x260mm - Lame 211mm double parois - Automatisme à vis sans fin caché - Aluminium thermolaqué Qualicoat / Qualimarine / Qualanod - Platine de fixation au sol - Led intégrées en périphérie - Boîtier de commande invisible avec télécommande et Application mobile (📱Android et 🍏Apple's IOS) | <ul style="list-style-type: none"> - Available as lean to and freestanding - Posts 154x154mm - Gutter beam 150x260mm - Double walled slats 211mm - Hidden worm-screw automation - Powder coated aluminum Qualicoat / Qualimarine / Qualanod - Floor mounting plate - Peripheral build-in LEDs - Invisible control box controled by remote control and smartphone app (📱Android and 🍏Apple's IOS) |
|--|---|

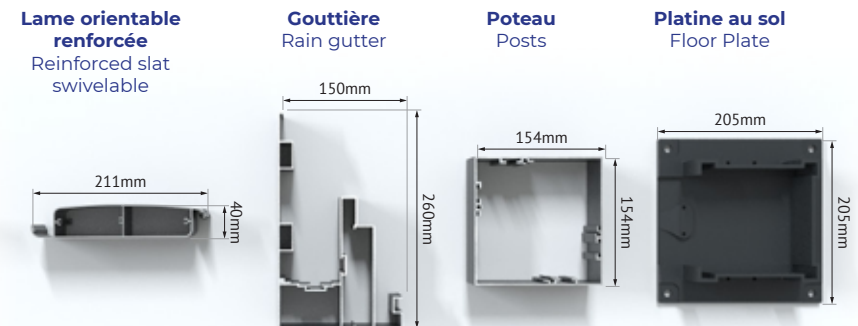

Résistance au VENT Resistance to WIND C6 (101,61km/h)	Perméabilité à l'EAU Permeability to WATER 2L (m ² x min)	Charge de NEIGE SNOW Load 90 kg/m ²
<div style="display: flex; align-items: center; justify-content: center;"> <div style="font-size: 2em; margin-right: 10px;">CE</div> <div> <p>Certifié ENAC - Laboratoire ENSATEC - CE NB 1668 n° de organisme notifié Classement - VENT C6 EN 13561</p> <p>Certified ENAC - Laboratory ENSATEC - CE NB 1668 notified entity number Ranking - VENT C6 EN 13561</p> </div> </div>		





PERGOLA BIOCLIMATIQUE
 PERGOLA BIOCLIMATIC

SUNNYCONTROL II

Caractéristiques | Characteristics

- | | |
|--|--|
| <ul style="list-style-type: none"> - Existe en adossé et autoportant - Poteau 100x100mm - Poutre gouttière 137x100mm - Aluminium thermolaqué Qualicoat / Qualimarine / Qualanod - Lame simple parois 212mm - Automatisation à vis sans fin visible - Platine de fixation au sol - Led intégrées sur deux cotés - Vis de fixation fournies - Boîtier de commande visible avec télécommande et Application mobile (📱 Android et 🍏 Apple's IOS) | <ul style="list-style-type: none"> - Available as lean to and freestanding - Posts 100x100mm - Gutter beam 137x100mm - Powder coated aluminum Qualicoat / Qualimarine / Qualanod - Single walled slats 212mm - Worm-screw visible automation - Floor mounting plate - two sides build-in LEDs - Fixing screws provided - Visible control box controlled by remote control and smartphone app (📱 Android and 🍏 Apple's IOS) |
|--|--|



Résistance au VENT
Resistance to WIND

C4

Certifié ENAC - Laboratoire ENSATEC - CE NB 1668 n° de organisme notifié Classement - VENT C4 EN 13561

Certified ENAC - Laboratory ENSATEC - CE NB 1668 notified entity number Ranking - WIND C4 EN 13561

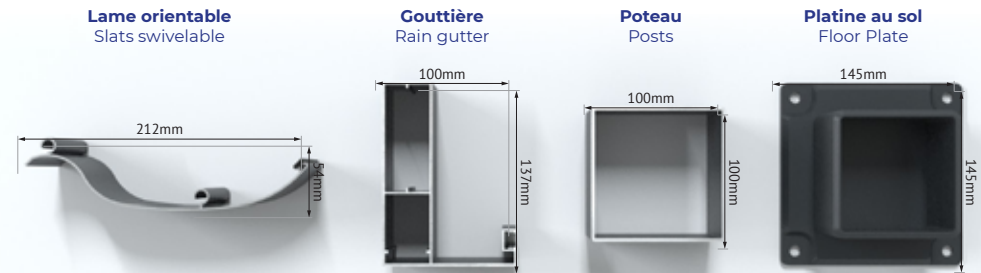





PERGOLA BIOCLIMATIQUE
 PERGOLA BIOCLIMATIC

EASY UP

Caractéristiques | Characteristics

- | | |
|--|---|
| - Existe en adossé et autoportant | - Available as lean to and freestanding |
| - Poteau 100x100mm | - Posts 100x100mm |
| - Poutre gouttière 171x147mm | - Gutter beam 137x100mm |
| - Aluminium thermolaqué Qualicoat / Qualimarine / Qualanod | - Powder coated aluminum Qualicoat / Qualimarine / Qualanod |
| - Lame simple parois 212mm | - Single walled slats 212mm |
| - Automatisation à vis sans fin invisible | - Covered worm-screw automation |
| - Platine de fixation au sol | - Floor mounting plate |
| - Led intégrées en le 4 cotés | - four sided build-in LEDs |
| - Vis de fixation fournies | - Fixing screws provided |
| - Boîtier de commande invisible avec télécommande et Application mobile (Android et Apple's IOS) | - Invisible control box controlled by remote control and smartphone app (Android and Apple's IOS) |

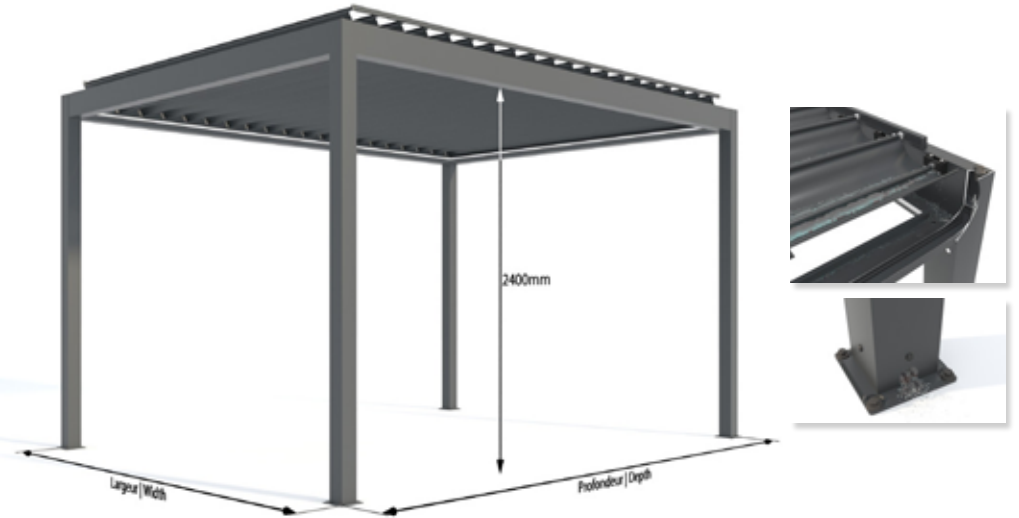

Résistance au VENT
 Resistance to WIND

C4

Certifié ENAC - Laboratoire ENSATEC - CE NB 1668 n° de organisme notifié Classement - VENT C4 EN 13561

Certified ENAC - Laboratory ENSATEC - CE NB 1668 notified entity number Ranking - WIND C4 EN 13561

Lame orientable
 Slats swivelable



Gouttière
 Rain gutter



Poteau
 Posts

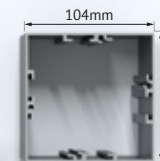

Platine au sol
 Floor Plate

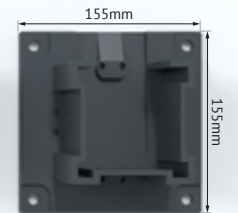



STORE VERTICAL VERTICAL BLIND

Caractéristiques | Characteristics

- Store vertical avec caisson et coulisse aluminium
 - Laquage label Qualicoat / Qualimarine / Qualanod
 - Axe en acier galvanisé
 - Lame finale avec joint epdm
 - Coulisse extrudée avec joint brosse intégrée
 - Motorisation NFI et récepteur radio avec sa télécommande multicanaux
 - Aluminium 100% recyclable
 - Toile polyester, PVC microperforé blanc ou gris anthracite
- Vertical blind with casing and aluminium rails
 - Aluminum lacquered Qualicoat/Qualimarine/Qualanod
 - Galvanized steel shaft
 - Final slat with EPDM seal
 - Guide rails extruded with integrated brush seals
 - Motorization NFI with radio control and own multi-channel remote control
 - 100% recyclable aluminum
 - Polyester fabric, PVC microperforated white or grey anthracite

Caractéristiques du Toile | Characteristics of the fabric

	Specifications Specifications	Méthode Method
Épaisseur Thickness	0,56 mm	
Masse totale Total mass	350 ± 30 g/m ²	EN ISO 2286-2
Masse du Support Carrying Weight	130 ± 10 g/m ²	EN ISO 2286-2
Charge de Rupture Rupture Load	L.: 40 daN/50mm ; T.: 30 daN/50mm	EN ISO 1421
Resistance à la Coupure Cut Resistance	L.: 40 daN ; T.: 30 daN	DIN 53363
Solidité de la couleur à la lumière Colour Fastness to Light	min 6	EN ISO 105-B02
Perméabilité moyenne à l'air Average Permeability to Air	3600 l/m ² /s	NP EN ISO 9237
Transmission moyenne à la lumière Average Light Transmission	24	SF 600 Plus Epectrofotometre SF 600 Plus Spektralphotometer
Comportement au feu Burning Behaviour	< 100 mm/min	DIN 75200
Air Ouvert Air Opening	23 %	Intérieure Interior

Toile Gris
Cloth Grey

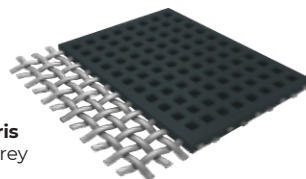

Toile Blanc
Cloth White

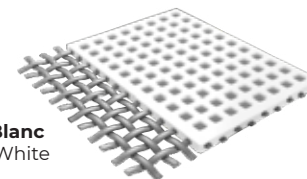



STORE VERTICAL ZIP VERTICAL BLIND ZIP

Caractéristiques | Characteristics

- Système élégant spécialement conçu pour que le tissu ne glisse pas hors des guides, grâce à sa fermeture,
 - Adapté aux extérieurs, balcons, façades et pergolas, sa fonction principale est de réduire la température et de couvrir les côtés des pergolas;
 - Idéal pour les petites et grandes longueurs;
 - Les guides incorporant une fermeture latérale maintiennent la toile plus stable et son fonctionnement plus précis, offrant ainsi une plus grande résistance au vent;
 - Offre efficacité, robustesse, sécurité et fiabilité;
 - Design simple et fonctionnelle;
 - Réduction des prises d'air et de la luminosité;
 - Étiquette Qualicoat / Qualimarine / Qualanod;
 - Axe en acier galvanisé;
 - Traverse finale avec poids intérieur pour faciliter la descente;
 - Motorisation NFI et récepteur radio avec sa télécommande multicanaux;
 - Aluminium 100% recyclable;
 - Tissu en polyester, PVC microformé blanc ou gris anthracite.
- Elegant system specially designed so that the fabric does not slip out of the guides, thanks to its closure,
 - Suitable for exteriors, balconies, facades and pergolas, its main function is to reduce the temperature and cover the sides of the pergolas;
 - Ideal for short and long lengths;
 - The guides incorporating a side closure keep the canvas more stable and its operation more precise, thus offering greater resistance to the wind;
 - Offers efficiency, robustness, safety and reliability;
 - Simple and functional design;
 - Reduction of air intakes and luminosity;
 - Qualicoat / Qualimarine / Qualanod label;
 - Galvanized steel axis;
 - Final crossbar with internal weight to facilitate the descent;
 - NFI motorization and radio receiver with its multi-channel remote control;
 - 100% recyclable aluminum;
 - Polyester fabric, white or anthracite gray microformed PVC.







RIDEAU DE VERRE GLASS CURTAIN

Caractéristiques | Characteristics

- Les rideaux sont des panneaux de verre coulissants, l'idéal pour fermer votre terrasse, balcon, Pergola etc. Garder l'espace frais en été et chaud en hiver.
 - Des lignes simples et modernes, sans interruption d'aluminium, qui font que les espaces semblent plus spacieux et accueillants.
 - Installation simple et rapide, sans nécessité d'une structure très robuste, car le poids est entièrement dans le seuil.
 - Composé d'un rail en aluminium de 100mm avec 4 canaux, qui permet jusqu'à 8 vantaux.
 - Verre feuilleté 5,5², collé sur un profilé inférieur de 20x84x1,5mm
 - Coulissant à l'intérieur d'un profil supérieur en aluminium également avec 4 canaux de 100 mm.
 - Rails latéraux en aluminium avec 25x25mm
- This curtains are sliding glass panels, ideal for closing your terrace, balcony, Pergola etc. They keep the temperature cool at summer and warm at winter.
 - Simple and modern lines, without aluminum interruptions, which make the spaces seem bigger and welcoming.
 - Simple and quick installation, without need for a very robust structure, since the weight is entirely in the threshold.
 - Composed of a 100mm aluminum rail with 4 channels, which allows up to 8 leaves.
 - Laminated glass 5.5², glued on a lower profile of 20x84x1.5mm
 - Sliding inside an upper aluminum profile also with 4 channels of 100 mm.
 - Aluminum side rails with 25x25mm

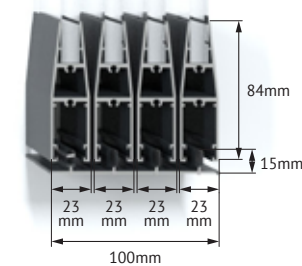
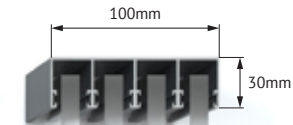





CLOISON DE CLAIRE VOIE PRIVACY SCREEN

Caractéristiques | Characteristics

- Cloison en aluminium aux lignes modernes, pour l'intimité de votre espace sans avoir besoin du passage d'air
- Composé de feuilles de 80x15mm qui sont induites à l'intérieur des gouttières avec des fentes pour eux
- aluminum partition with modern lines, for the privacy of your space without needing the air passage
- Consisting of 80x15mm sheets that are induced inside gutters with slots for them



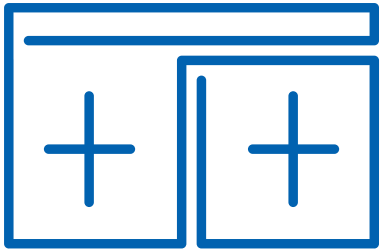

VERANDA GLASS ROOM

043 Veranda
Glass room

047 Jardin d'Hiver Contemporain
Winter Garden Contemporain

049 Jardin d'Hiver Classic
Winter Garden Classic



VERANDA GLASS ROOM

Caractéristiques | Characteristics

- Toiture pré-assemblé en atelier, photo et vidéo pour confirmation de la faisabilité et de la qualité des finitions
- Véritable toiture plate avec double toiture, panneau sandwich acier CE 100mm, laine de verre 50mm et panneau sandwich 30 mm avec renfort pente de 1 à 4 %
- Volet roulant lame de 50 mm, motorisation radio et télécommande multicanaux
- Eclairage Led périphérique intérieur et extérieur - gestion de luminosité, on/off et variation par radio
- Menuiserie RPTH CONSENSUS II, avec vitrage 4.20.4 warm edge, fe gaz argon, tri-rail, meneau minimaliste de 20mm avec renfort, fermeture jusqu'à 3 points avec option C
- Faitière/Sablère périphérique
- Chéneau et réhausse périphérique avec système d'equerre d'alignement
- Caisson de volet roulant périphérique
- Préparation des évacuation d'eau dans le chéneau, 2 sorties par angle en façade
- Visserie inox classe A2
- Conforme rt 2012
- Les profilés constituant la gamme véranda LUMINEAL titanium sont obtenus par filage à la presse, avec un alliage n°6060 AGTS elon normes NF A50710, NF EN 573,3, NF EN 7585,1, NF EN 755,2, NF EN 12020,1 et NF EN 12020,2
- Les profilés en alliage n°. 6060 qualité bâtiment dont les tolérances concernant le taux d'impureté est plus strict que la norme
- Véranda avec structure et charpente aluminium
- Les profilés sont labelisés qualicoat, qualimarine, qualanod, qualidécór et ont une garantie de 10 ans
- La garantie de la veranda selon nos cvg est garantie 10 ans
- Les vitrage sont labelisé CEKAL
- La véranda à été testé par un laboratoire indépendant ainsi par une étude DPE certifié
- La mise en œuvre répond aux exigences des règles professionnelles vérandas à structure aluminium du SNFA (juillet 2011)
- Roof pre-assembled in the workshop, photo and video to confirm the feasibility and quality of the finishes
- True flat roof with double roof, steel sandwich panel CE 100mm, glass wool 50mm and sandwich panel 30 mm with slope reinforcement from 1 to 4%
- Roller shutter with 50mm slat, radio motorization and multi-channel remote control
- Indoor and outdoor peripheral LED lighting - light management, on / off and dimming by radio
- RPTH CONSENSUS II joinery, with glazing 4.20.4 warm edge, fe argon gas, tri-rail, minimalist 20mm mullion with reinforcement, closing up to 3 points with option C
- Peripheral Rain gutter
- Gutter and peripheral riser with alignment bracket system
- Peripheral rolling shutter box
- Preparation of water evacuation in the gutter, 2 exits per facade angle
- Stainless steel screws class A2
- 2012 rt compliant
- The profiles constituting the LUMINEAL titanium veranda range are obtained by press spinning, with an alloy no. 6060 AGTS according to standards NF A50710, NF EN 573.3, NF EN 7585.1, NF EN 755.2, NF EN 12020 , 1 and NF EN 12020.2
- Alloy profiles no. 6060, building quality, the tolerances for which are higher than the standard
- Veranda with aluminum structure and frame
- The profiles are labeled qualicoat, qualimarine, qualanod, qualidécór, a 10 year warranty
- The veranda guarantee according to our terms and conditions is guaranteed 10 years
- The glazing is CEKAL certified
- The veranda has been tested by an independent laboratory and by a certified DPE study
- The implementation meets the requirements of the professional verandas with aluminum structure of the SNFA (July 2011)

FICHE TECHNIQUE

TECHNICAL SHEET

Conductivité
THERMIQUE EXT.
Ext. Thermal
CONDUCTIVITY



0,707 w/mk

Conductivité
THERMIQUE INT.
Int. Thermal
CONDUCTIVITY



0,276 w/mk

Résistance
au VENT
Resistance to
WIND



C6 (101,61km/h)

Perméabilité
à l'EAU
Permeability to
WATER



2L (m² x min)

Charge de NEIGE
SNOW Load



125 Kg/m²

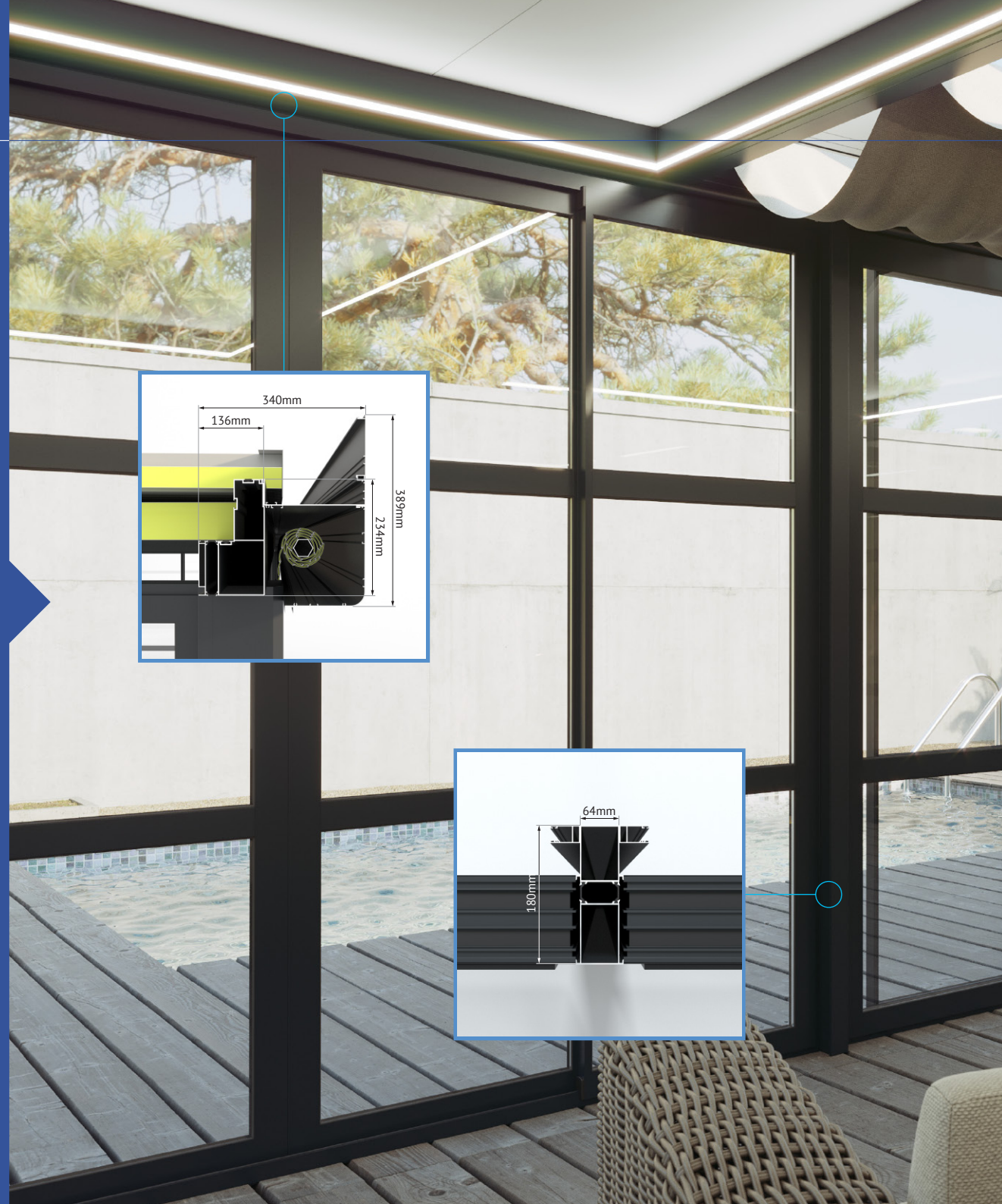
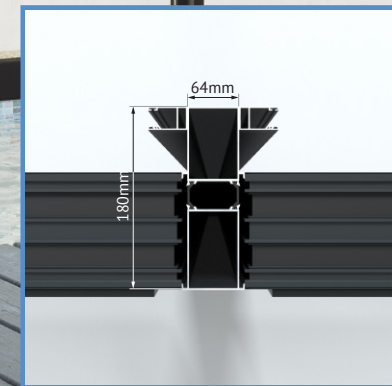
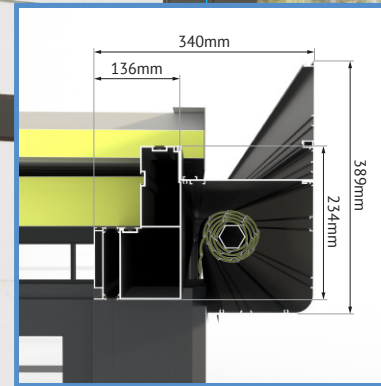

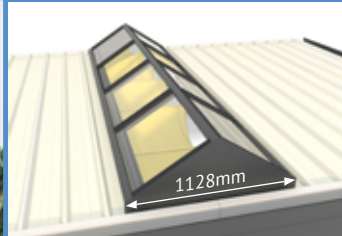

Puit de lumière avec Velum
Skylight with shade cloth

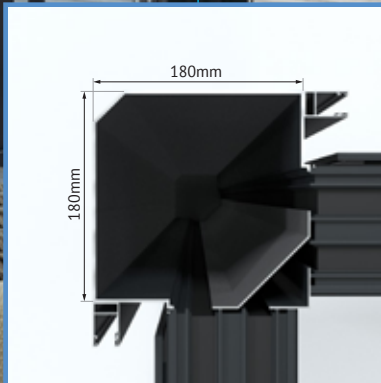







JARDIN D'HIVER CONTEMPORAIN

WINTER GARDEN CONTEMPORAIN

Caractéristiques | Characteristics

- Existe en adossé seulement
 - Poteau 100x100mm et Poutre gouttière 288x100mm ou 438x100mm
 - Chevron 80x40mm
 - Inclinaison cachée mono pente
 - Aluminium thermolaqué Qualicoat / Qualimarine / Qualanod
 - Platine de fixation au sol
 - Panneau de polycarbonate opale 16mm traité anti UV avec obturateur poly, adhésif microperforé
- Available only as lean to
 - Posts 100x100mm and Gutter beam 288x100mm or 438x100mm
 - Rafters 80x40mm
 - Hidden one slope
 - Powder coated aluminum Qualicoat / Qualimarine / Qualanod
 - Floor mounting plate
 - Opal polycarbonate panel 16mm treated anti UV with poly shutter, microperforated adhesive

<p>Résistance au VENT Resistance to WIND</p>  <p>C6 (101,61km/h)</p>	<p>Perméabilité à l'EAU Permeability to WATER</p>  <p>2L (m² x min)</p>	<p>Charge de NEIGE SNOW Load</p>  <p>100 kg/m²</p>
<p>CE Certifié ENAC - Laboratoire ENSATEC - CE NB 1668 n° de organisme notifié Classement - VENT C6 EN 13561</p> <p>Certified ENAC - Laboratory ENSATEC - CE NB 1668 notified entity number Ranking - WIND C6 EN 13561</p>		

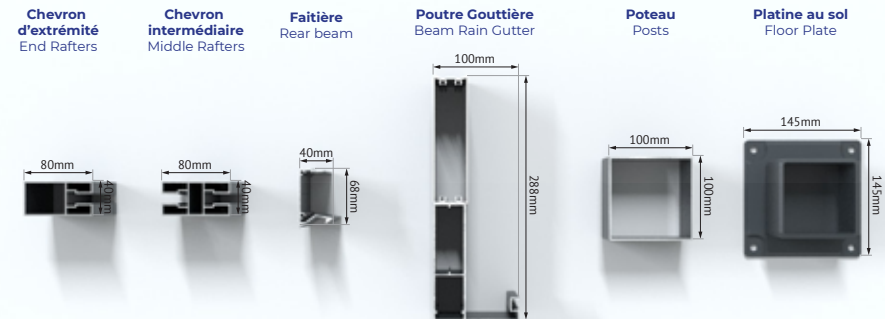
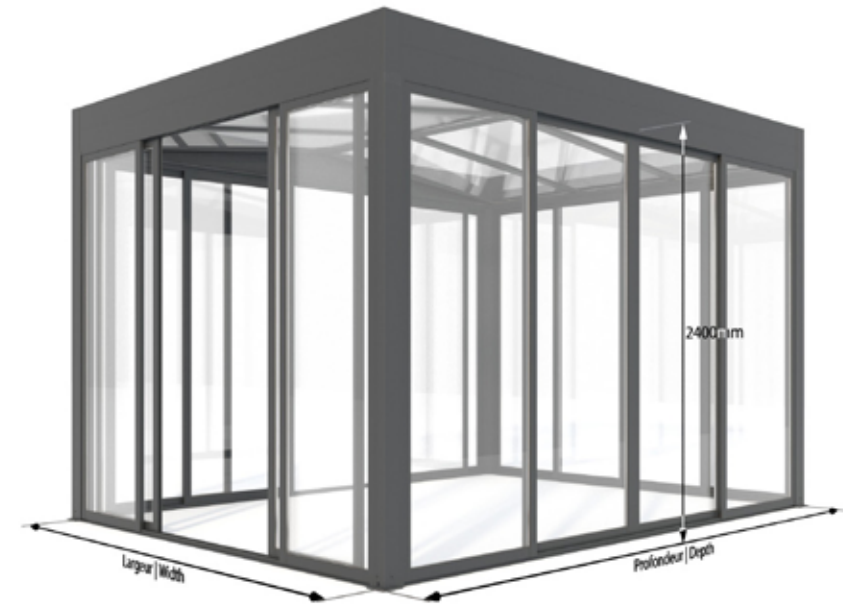





JARDIN D'HIVER CLASSIC

WINTER GARDEN CLASSIC

Caractéristiques | Characteristics

- Poteau et faitière 120x64mm
- Gouttière 93x141mm
- Chevron 80x40mm
- Aluminium thermolaqué Qualicoat / Qualimarine / Qualanod
- Polycarbonate opale 16mm traité anti UV avec obturateur poly, adhésif microperforé, en option polycarbonate 10mm ou 32mm
- Platine de fixation au sol
- Vis de fixation fournies
- Fermeture aluminium sans rupture de pont thermique
- Vitrage 4.8.4

- Posts and beams 120x64mm
- Rain gutter 93x141mm
- Rafters 80x40mm
- Powder coated aluminum Qualicoat / Qualimarine / Qualanod
- Polycarbonate opal 16mm treated anti UV with poly shutter, adhesive microperforated, as optional 10mm or 32mm
- Floor mounting plate
- Fixing screws provided
- Aluminum windows without thermal break
- Glazing 4.8.4

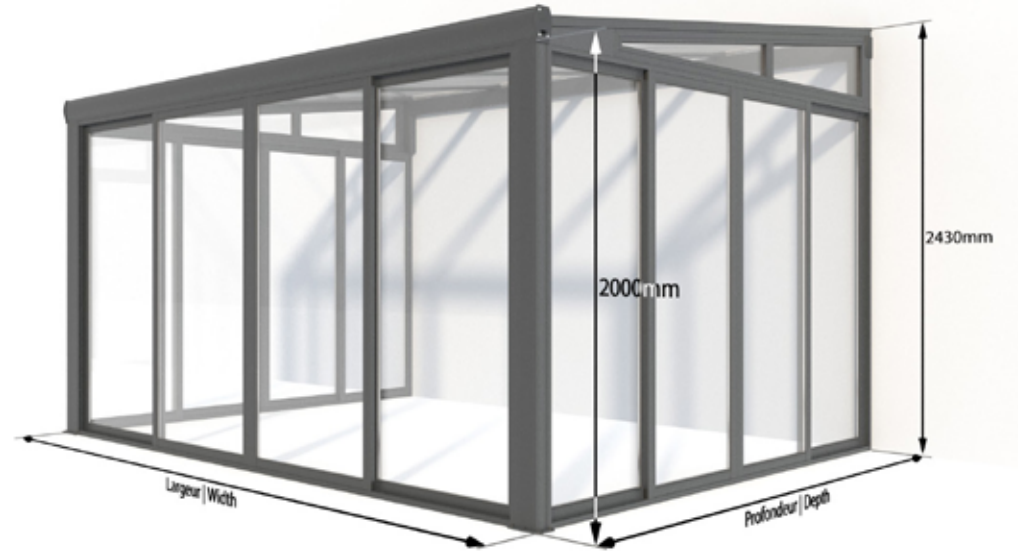

Résistance au VENT
Resistance to WIND

C5



Certifié ENAC - Laboratoire ENSATEC -
CE NB 1668 n° de organisme notifié
Classement - VENT C5
EN 13561

Certified ENAC - Laboratory ENSATEC -
CE NB 1668 notified entity number
Ranking - WIND C5
EN 13561

Chevron
d'extrémité
End Rafters

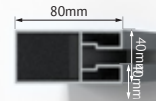

Chevron
intermédiaire
Middle Rafters

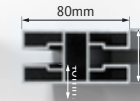

Gouttière
Rain Gutter



Poteau
Post



Platine au sol
Floor Plate





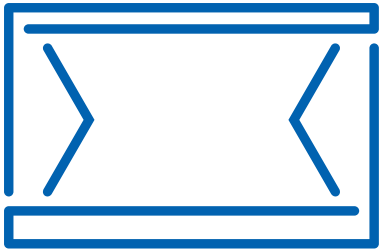

STORE-BANNE AWNING

Caractéristiques | Characteristics

- Store de grande projection
- Largeur maximale: 6050mm selon vos mesures
- Profondeur (projection) maximale: 3500mm
- Store autoportant avec 2 accroches rapides
- Pose façade
- Coffre fermé pour une protection de la toile optimale
- Toile acrylique teintée dans la masse 300 g/m² pour des couleurs éclatantes et durables
- Traitement imperméabilisant, double couture
- Réglage de la hauteur latérale des bras
- Griffe variateur permettant d'aligner la barre de charge au coffre et plot de guidage
- Résistance suivant la nouvelle norme européenne EN13561:2015
- Structure à l'épreuve du temps, profil extrudé aluminium et pièce fonderie
- Motorisation NFI et récepteur radio avec sa télécommande individuelle
- Transmission par 2 câbles
- Large projection awning
- Maximum width: 6050mm according to your measurements
- Maximum depth (projection): 3500mm
- Freestanding blind with 2 quick hooks
- Facade installation
- Closed chest for optimal canvas protection
- Acrylic canvas tinted in the mass 300 g / m² for vibrant and lasting colors
- Waterproofing treatment, double stitching
- Adjustment of the lateral height of the arms
- Variator claw to align the load bar to the boot and guide pad
- Resistance according to the new European standard EN13561: 2015
- Element proof structure, extruded aluminum profile and foundry part
- NFI motor and radio receiver with individual remote control
- Transmission by 2 cables

Résistance
au VENT
Resistance to
WIND



CI (32,13km/h)

- Résistance à la traction en N (Une en ISO 13934-1) : Ch/ 1400, Tr/ 950
- Allongement au point de rupture en % (Une en ISO 13934-1) : Ch/ 28, Tr/25
- Résistance au déchirement en N (Une en ISO 40404) : Ch/ 40, Tr/ 30
- Résistance des couleurs aux UV (Une en ISO 105B02) : 7 (très bonne)
- Résistance à la pénétration de l'eau cmH2O (Une en ISO 20811) : 30+ cm
- Poids : 300 g/m²

- Tensile strength in N (One as ISO 13934-1): Ch/ 1400, Tr/ 950
- Elongation at breaking point in % (One as ISO 13934-1): Ch/ 28, Tr/25
- Tear strength in N (One as ISO 40404): Ch/ 40, Tr/ 30
- Color fastness to UV (One as ISO 105B02): 7 (very good)
- Resistance to water penetration cmH2O (One as ISO 20811): 30+ cm
- Weight: 300g/m²



EN13561:2015

COLLECTION DE TOILES | CANVAS COLLECTION

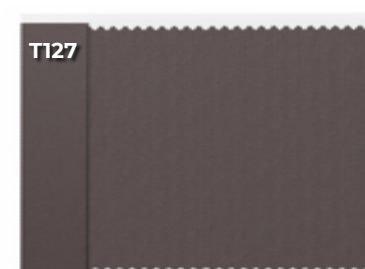
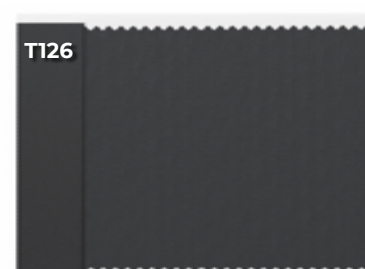
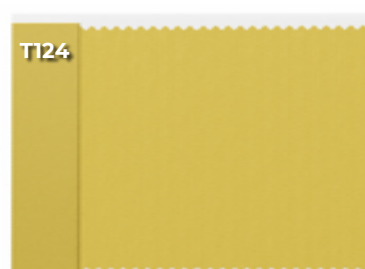
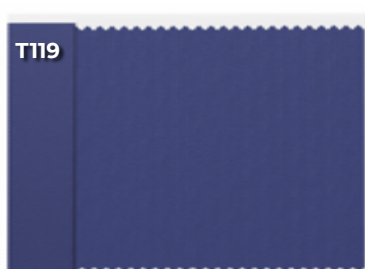
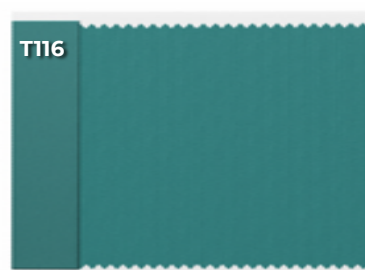
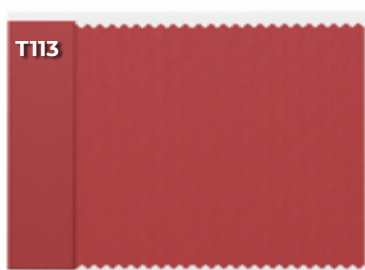
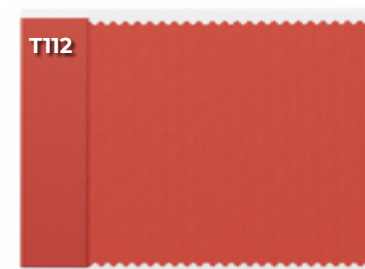

COLLECTION DE TOILES | CANVAS COLLECTION

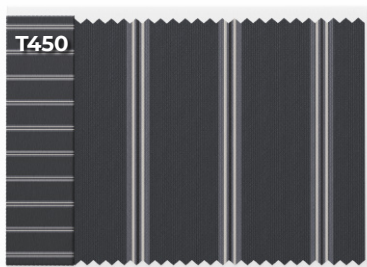
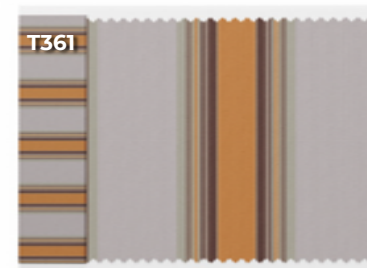
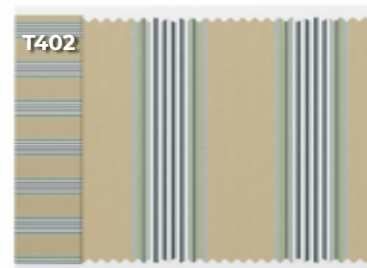
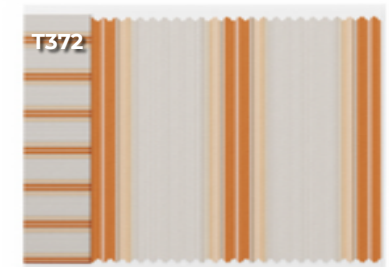
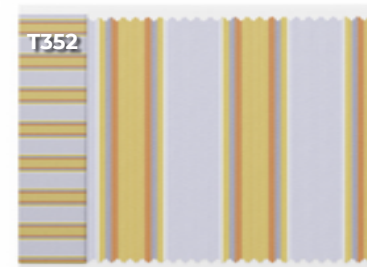
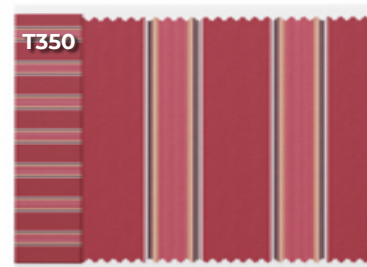
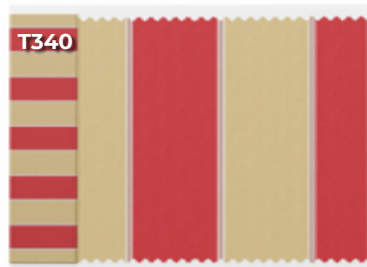
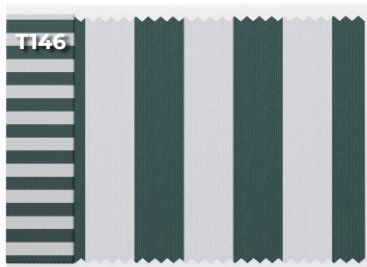
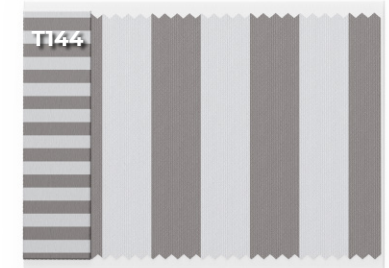
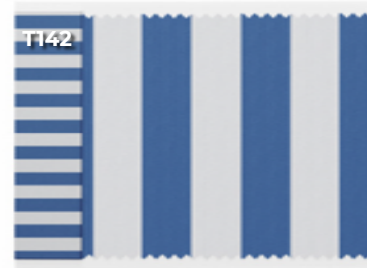
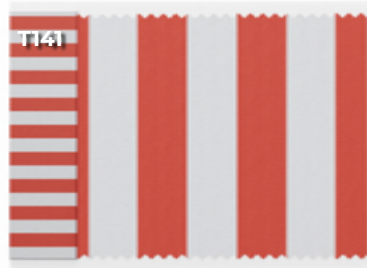
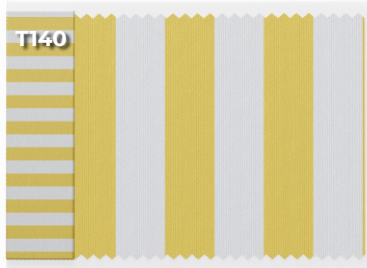



NOUVELLES FERMETURES INTERNACIONAL

**Rua da Braziela, n°51 Fradelos
4760 – 564 Vila Nova de Famalicão, Portugal**

Tel.: (00 351) 252 412 734
Tel. (fr): 06 25 57 24 36
Fax: (00 351) 252 412 735
Email: commerce@nfi.pt
Online: www.nfi.pt



**Wismar-NFI Vertriebs GmbH
Robert- Bosch- Str. 2
D- 68542 Heddesheim, Deutschland**

Tel.: 06203-40440
Fax.: 06203-404424
E- mail: info@wismar-nfi.de

 Tout le contenu, photos, textes et graphiques sont protégés par copyright. Vous ne pouvez pas sans le consentement écrit préalable de NFI - Nouvelles Fermetures International en tout ou en partie, être copié, modifié, reproduit ou publié.

La société NFI - Nouvelles Fermetures International insiste sur le fait de vérifier régulièrement son image de marque.

 All contents, photos, texts and graphic arts are protected by copyright. They may be changed not without previous written approval of NFI - Nouvelles Fermetures International neither completely nor in extracts copied, be multiplied or be published.

The company NFI - Nouvelles Fermetures International insists on verifying its trademark at any time.

 Sämtliche Inhalte, Fotos, Texte und Graphiken sind urheberrechtlich geschützt. Sie dürfen ohne vorherige schriftliche Genehmigung durch NFI - Nouvelles Fermetures International weder ganz noch auszugsweise kopiert, verändert, vervielfältigt oder veröffentlicht werden. Die Gesellschaft NFI - Nouvelles Fermetures International besteht darauf ihr Markenzeichen jederzeit zu überprüfen.



ER-0178/2019

